

TITE-LOC PLUS - WOOD SUBSTRATE DETAILS

RAKEWALL - OPTION 2

(1-PC REGLET - FLOATING)

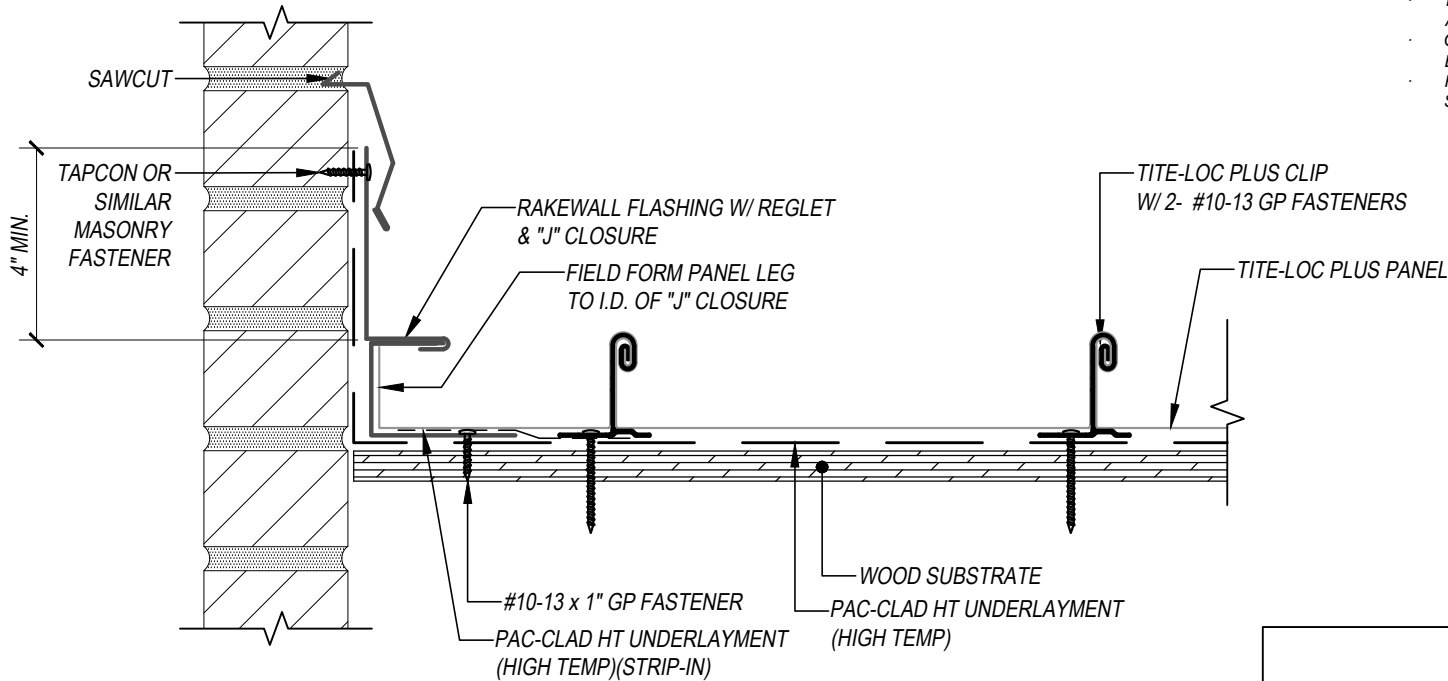
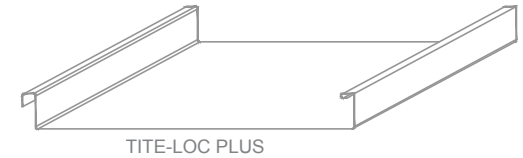

KEYNOTES:

- TRIM FASTENERS ARE SELF-TAPPING PANCAKE HEAD AND MUST BE INSTALLED IN A STAGGERED PATTERN
- CLIP FASTENERS MUST PENETRATE WOOD SUBSTRATE BY 5/8" MINIMUM THREAD LENGTH
- FASTENER SPACING VARIES BASED ON PROJECT SPECIFIC LOADS AND/OR LOCAL BUILDING CODES

SCALE: 3" = 1'-0"

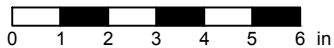

EFFECTIVE DATE: 01-03-2023
SUBJECT TO CHANGE WITHOUT NOTICE

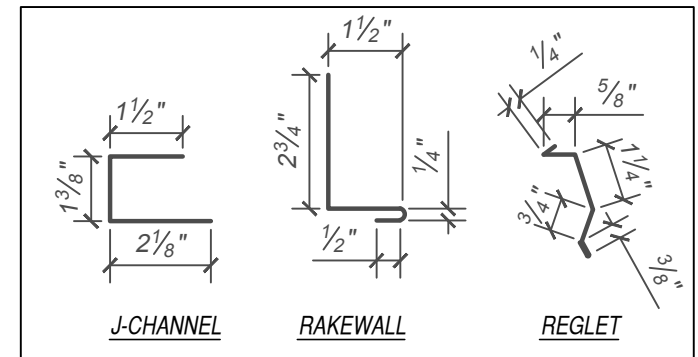

DISCLAIMER: DETAIL SHOWN FOR ILLUSTRATION PURPOSES ONLY. ACTUAL PROJECT DETAIL MAY VARY