

TITE-LOC PLUS - WOOD SUBSTRATE DETAILS EAVE - OPTION 2 (RETAINER CLIP)

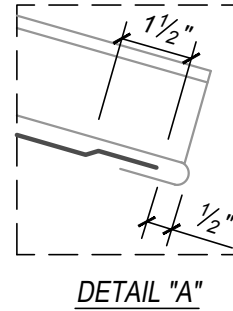
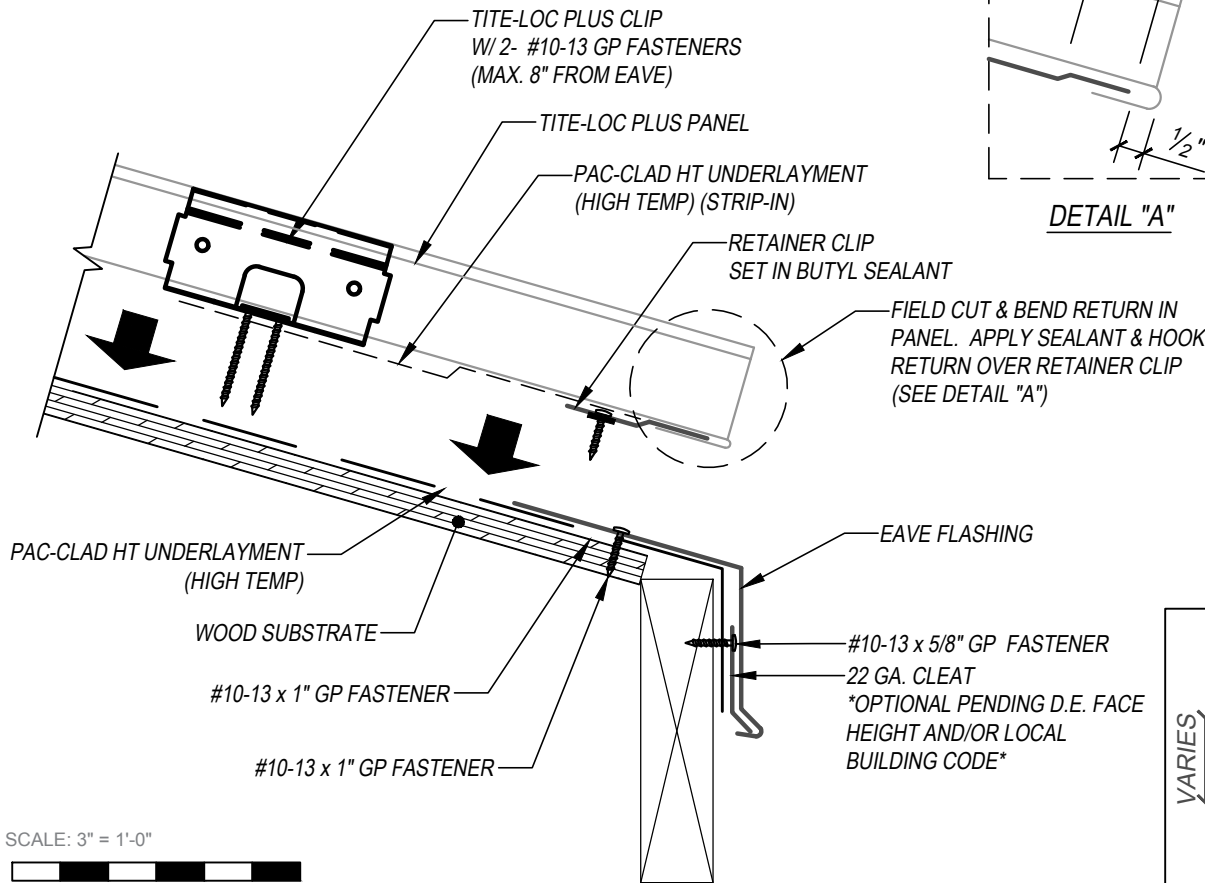
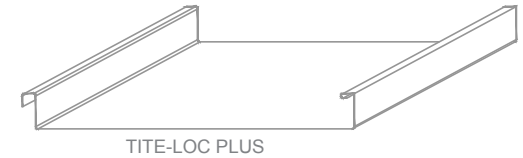

KEYNOTES:

- TRIM FASTENERS ARE SELF-TAPPING PANCAKE HEAD AND MUST BE INSTALLED IN A STAGGERED PATTERN
- CLIP FASTENERS MUST PENETRATE WOOD SUBSTRATE BY 5/8" MINIMUM THREAD LENGTH
- FASTENER SPACING VARIES BASED ON PROJECT SPECIFIC LOADS AND/OR LOCAL BUILDING CODES

FLUSH WALL OPTION

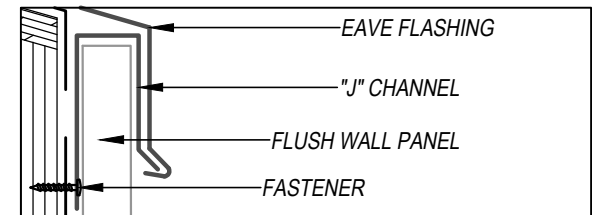

STANDING SEAM WALL OPTION

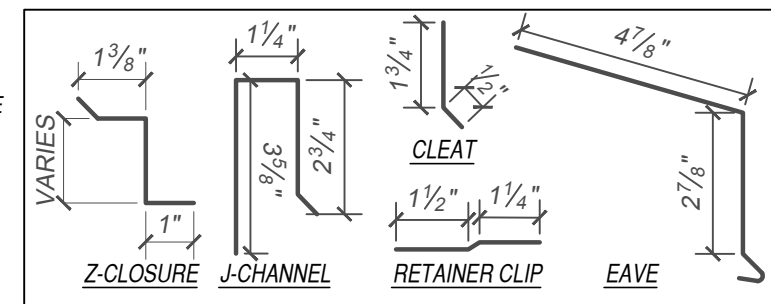
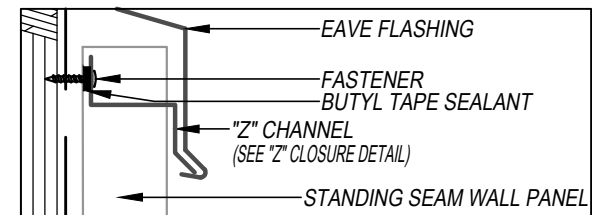

SCALE: 3" = 1'-0"

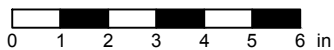

EFFECTIVE DATE: 01-03-2023
SUBJECT TO CHANGE WITHOUT NOTICE

DISCLAIMER: DETAIL SHOWN FOR ILLUSTRATION PURPOSES ONLY. ACTUAL PROJECT DETAIL MAY VARY