

# TITE-LOC PLUS - METAL DECK / ISO SUBSTRATE DETAILS EAVE - OPTION 2 (RETAINER CLIP)

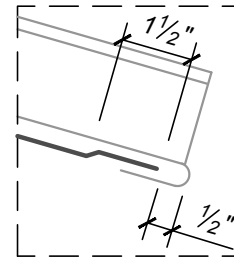
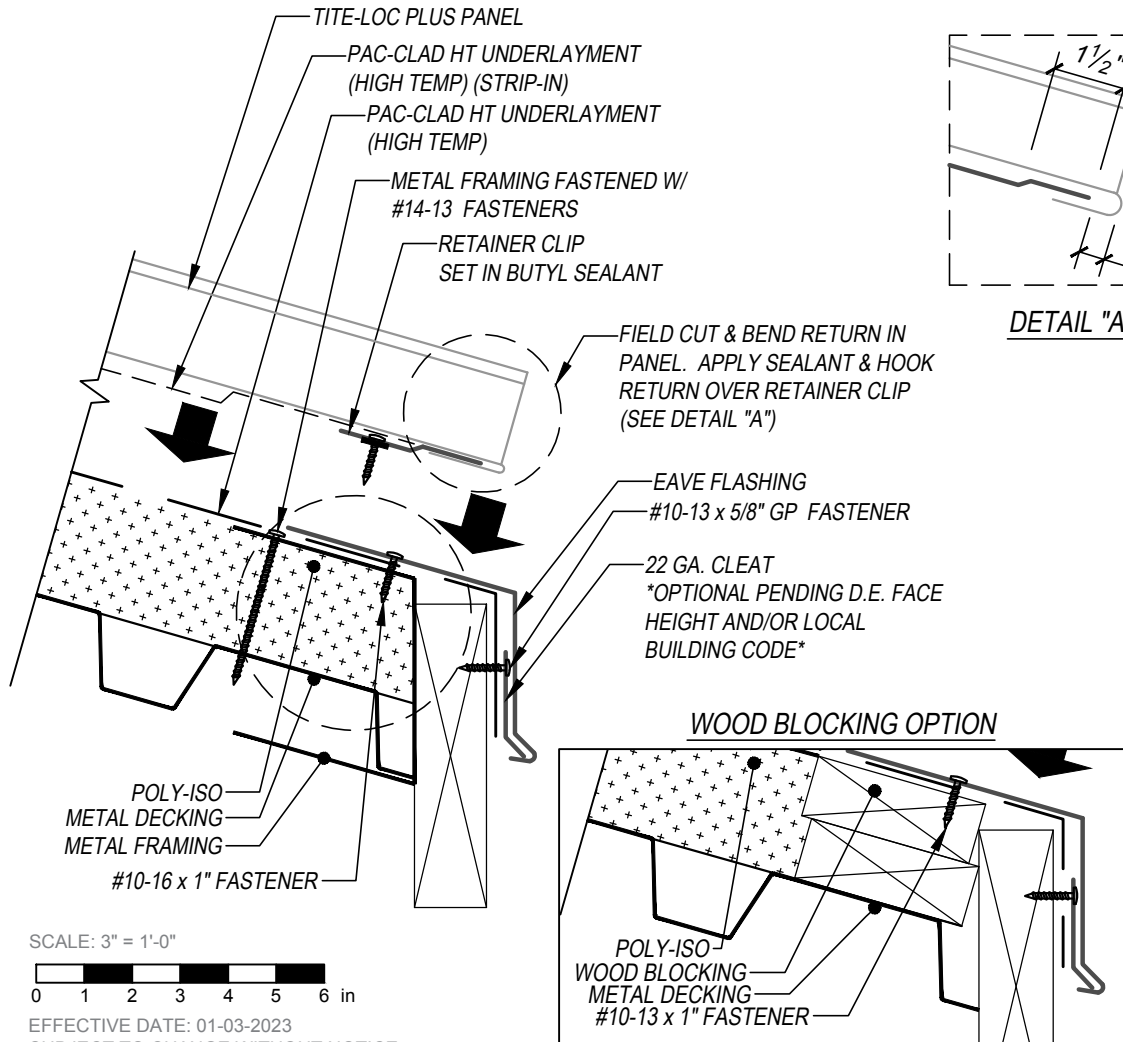
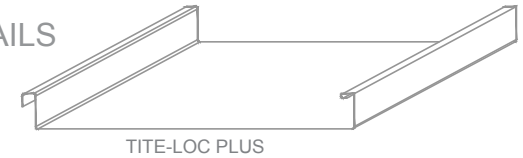

**KEYNOTES:**

- TRIM FASTENERS ARE SELF-TAPPING PANCAKE HEAD AND MUST BE INSTALLED IN A STAGGERED PATTERN
- CLIP FASTENERS MUST PENETRATE TOP FLUTE OF METAL DECK SUBSTRATE BY 5/8" MINIMUM THREAD LENGTH
- FASTENER SPACING VARIES BASED ON PROJECT SPECIFIC LOADS AND/OR LOCAL BUILDING CODES

**FLUSH WALL OPTION**

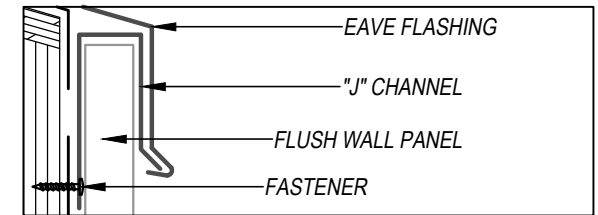

**STANDING SEAM WALL OPTION**

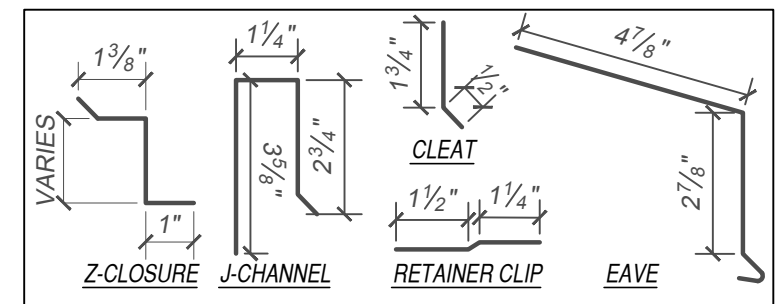
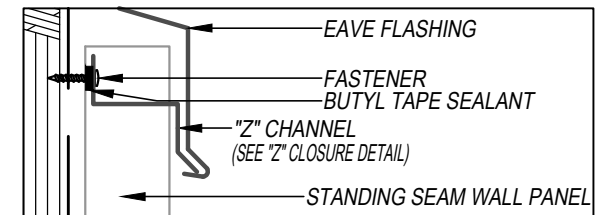

DISCLAIMER: DETAIL SHOWN FOR ILLUSTRATION PURPOSES ONLY. ACTUAL PROJECT DETAIL MAY VARY

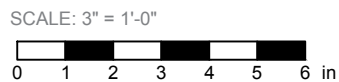

EFFECTIVE DATE: 01-03-2023  
SUBJECT TO CHANGE WITHOUT NOTICE