

# SNAP-ON STANDING SEAM - WOOD SUBSTRATE DETAILS

## EAVE - OPTION 1 (DRIP EDGE)

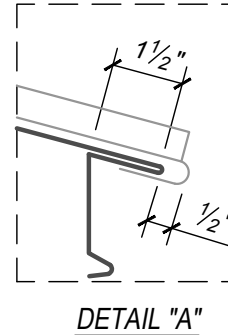
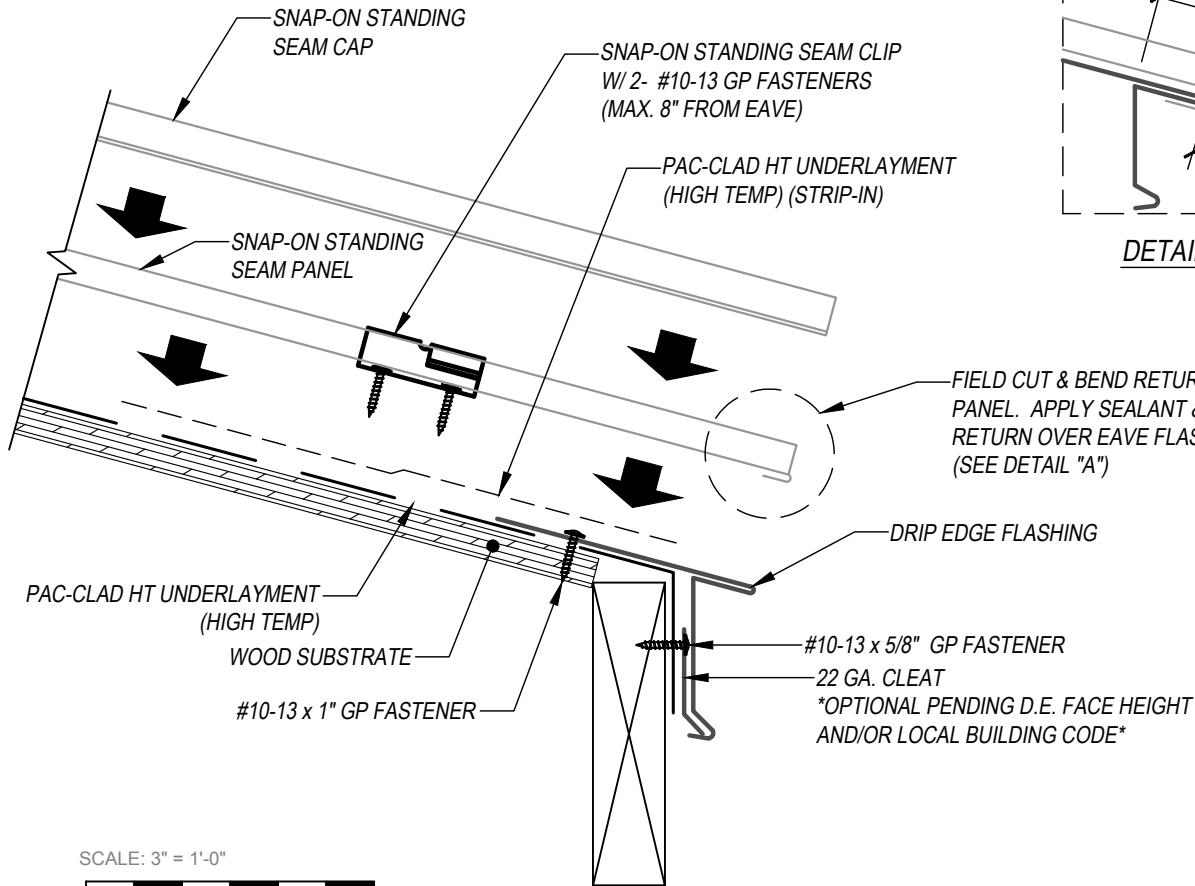
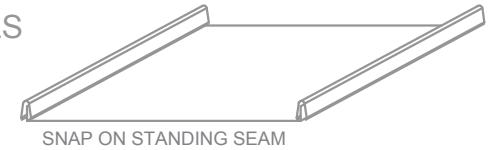

**KEYNOTES:**

- TRIM FASTENERS ARE SELF-TAPPING PANCAKE HEAD AND MUST BE INSTALLED IN A STAGGERED PATTERN
- CLIP FASTENERS MUST PENETRATE WOOD SUBSTRATE BY 5/8" MINIMUM THREAD LENGTH
- FASTENER SPACING VARIES BASED ON PROJECT SPECIFIC LOADS AND/OR LOCAL BUILDING CODES

**FLUSH WALL OPTION**

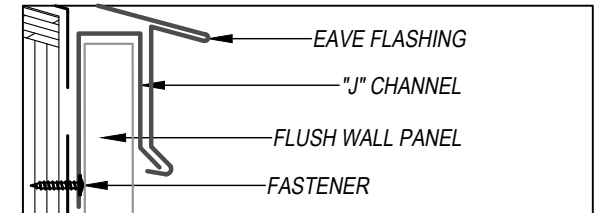

**STANDING SEAM WALL OPTION**

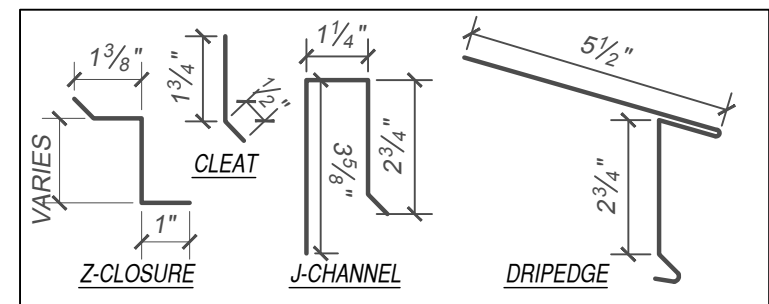
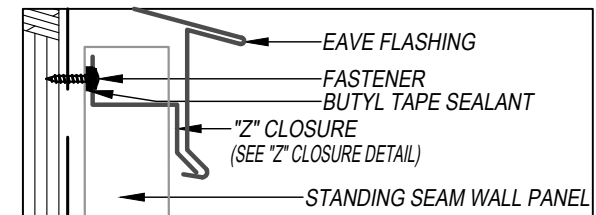

FLASHINGS

SCALE: 3" = 1'-0"

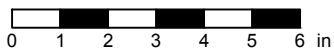

EFFECTIVE DATE: 01-03-2023  
SUBJECT TO CHANGE WITHOUT NOTICE

DISCLAIMER: DETAIL SHOWN FOR ILLUSTRATION PURPOSES ONLY. ACTUAL PROJECT DETAIL MAY VARY