



Farabaugh Engineering and Testing Inc.

Project No. T140-19

Report Date: February 25, 2019

Total Pages: 26 pages (inclusive)

FM 4474
SIMULATED WIND UPLIFT RESISTANCE OF ROOF ASSEMBLIES
IN ACCORDANCE WITH FM STANDARD 4474, APPENDIX D

ON

T-PANEL - METAL ROOF PANEL
16" WIDE X 24 GA. STEEL
WITH CONTINUOUS CLIPS AND INTERMITTENT CLIPS
(5 SPANS @ 5'-0" O.C. & 12 SPANS @ 2'-0" O.C.)

FOR

PETERSEN ALUMINUM CORP.
10551 PAC ROAD
TYLER, TX. 75707

Report Prepared By:

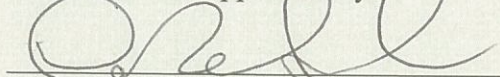

Paul G. Farabaugh

Reviewed and Approved By:

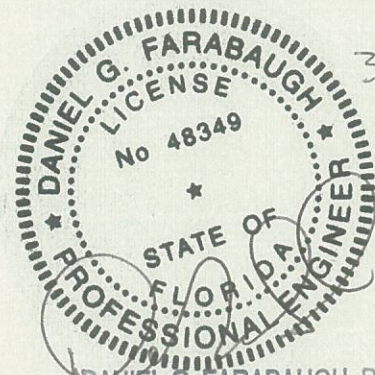
Daniel G. Farabaugh

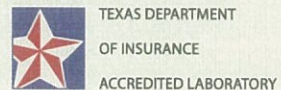

DANIEL G. FARABAUGH, P.E.
255 Saunders Station Rd.
Trafford, PA 15085
(412) 373-9238



Project No. T140-19

FM 4474-2004
AMERICAN NATIONAL STANDARD FOR EVALUATING THE SIMULATED WIND
UPLIFT RESISTANCE OF ROOF ASSEMBLIES USING STATIC POSITIVE AND /OR
NEGATIVE DIFFERENTIAL PRESSURES
(APPENDIX D)

Purpose

This test method covers the evaluation of the simulated wind uplift resistance of roof assemblies by using static positive and /or negative differential pressures. The standard applies to all components as assembled in the roof system.

Test Date

2/13/19 Test #1 - 5 Spans @ 5'-0" o.c. with intermittent clips
2/19/19 Test #2 - 5 Spans @ 5'-0" o.c. with continuous clips
2/18/19 Test #3 - 12 Spans @ 2'-0" o.c. with intermittent clips
2/22/19 Test #4 - 12 Spans @ 2'-0" o.c. with continuous clips

Test Specimen

Manufacturer: Petersen Aluminum
10551 PAC Rd.
Tyler, TX. 75707

Panel: T-PANEL - Metal Roof Panel, 16" wide x 24 ga. steel with 24 ga. steel cap

Intermittent Clip: 6" wide x 16 ga. galvanized steel clip

Continuous Clip: 120" wide x 16 ga. galvanized steel clip

Testing Apparatus

The pressure test chamber measured 13' wide x 26' long x 8" deep. Air pressure was maintained from below the roof assembly. A controlled blower provided a pressure to uniformly load the specimen mock-up. Two static pressure taps located at diagonally opposite corners served as the manometer connection. Calibrated manometers were used to measure the pressure at each pressure tap. The uniform load pressure was performed in the negative direction to monitor wind uplift on the panel specimen mock-up. Calibrated deflectometers were attached to monitor panel deformation as shown.

Installation

- The panels were installed on to 16 ga supports with using (2) #14-13 X 1-1/2" long, DP1, Concealor, self-drill fasteners per intermittent/continuous clips at supports. Test #1 & Test #3 used intermittent clips and Test #2 & #4 used continuous clips. Additional screw was used at each end of a continuous clip. The panel sidejoints used a 24 ga. seam cap and were seamed with a mechanical seamer. The seam cap used 2 beads of factory sealant, one bead on each side of cap corners. The panel ends were fastened with (5) 1/4-14 x 1-1/2 long, self-drill, hex head fasteners with washer. The outer side panels were fastened with (2) 1/4-14 x 1-1/2" long self- drill, hex head fasteners with washer at each support along each side of the mock-up.
- Plastic (4 mil thick) was employed loosely between the panels and subgirts and in the side joints to create a vacuum seal.

Procedure

- The specimen was checked for proper adjustment and all vents closed in the pressure measuring lines.
- The required deflection measuring apparatus were installed at their specified locations.
- A nominal initial pressure was applied equal to at least four times but not more than ten times the dead weight of the specimen. This nominal pressure was used as the reference zero and initial deflection readings were recorded.
- At each load increment, pressure was maintained for a period of not less than 60 seconds and until the deflection gages indicated no further increase in deflections.
- Successive increments were achieved as above until failure or ultimate load was reached.

The test was conducted according to the procedure in FM 4474 (Appendix D) and as noted herein. In our opinion the tape and plastic had no influence on the results of the test.

Project No. T140-19

TEST #1

Specimen: T-PANEL - Metal Roof Panel, 16" wide x 24 ga. steel with intermittent Clip

Clip Spacing: 5 ft o/c

NEGATIVE (UPLIFT) PRESSURE

PETERSEN ALUM. T-PANEL 16" WIDE X 24 GA. STEEL (5 SPANS @ 5' O.C.) INTERMITTENT CLIP

LOAD (PSF)	DEFLECTION DIAL READINGS (INCHES)					
	D-1	D-2	D-3	D-4	D-5	D-6
0.0	0.000	0.000	0.000	0.000	0.000	0.000
5.2	0.018	0.303	0.023	0.297	0.013	0.278
0.0	0.004	0.006	0.003	0.009	0.003	0.006
10.4	0.041	0.828	0.063	0.793	0.039	0.790
0.0	0.007	0.022	0.009	0.026	0.006	0.020
15.6	0.060	1.654	0.100	1.567	0.058	1.583
0.0	0.009	0.047	0.013	0.048	0.008	0.039
20.8	0.067	2.358	0.124	2.264	0.065	2.272
0.0	0.008	0.061	0.015	0.063	0.011	0.051
31.2	0.115	3.204	0.172	3.103	0.088	3.103
0.0	0.011	0.088	0.010	0.094	0.020	0.082
41.6	0.189	3.742	0.223	3.685	0.125	3.634
0.0	0.027	0.105	0.031	0.115	0.030	0.093
52.0	0.293	4.192	0.243	4.204	0.161	4.082
0.0	0.056	0.177	0.067	0.178	0.053	0.167
62.4	0.474	4.670	0.239	4.779	0.185	4.392
0.0	0.089	0.175	0.113	0.204	0.070	0.104

RESULTS:

Based on FM 4474 Test Method Appendix D

Maximum Test Load Rating (held for 1 min.) = 60.0 psf

Additional Test Pressure that was held for a minute was 67.6 psf

Maximum Test Load = 72.8 psf (Panel disengaged from clip)

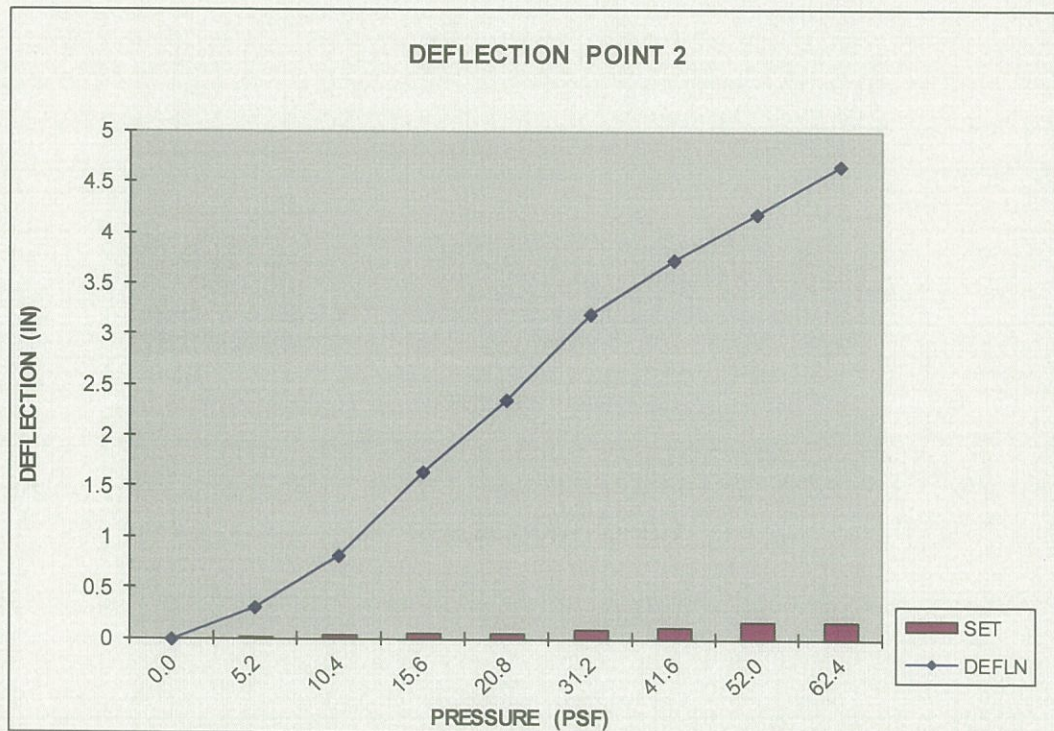
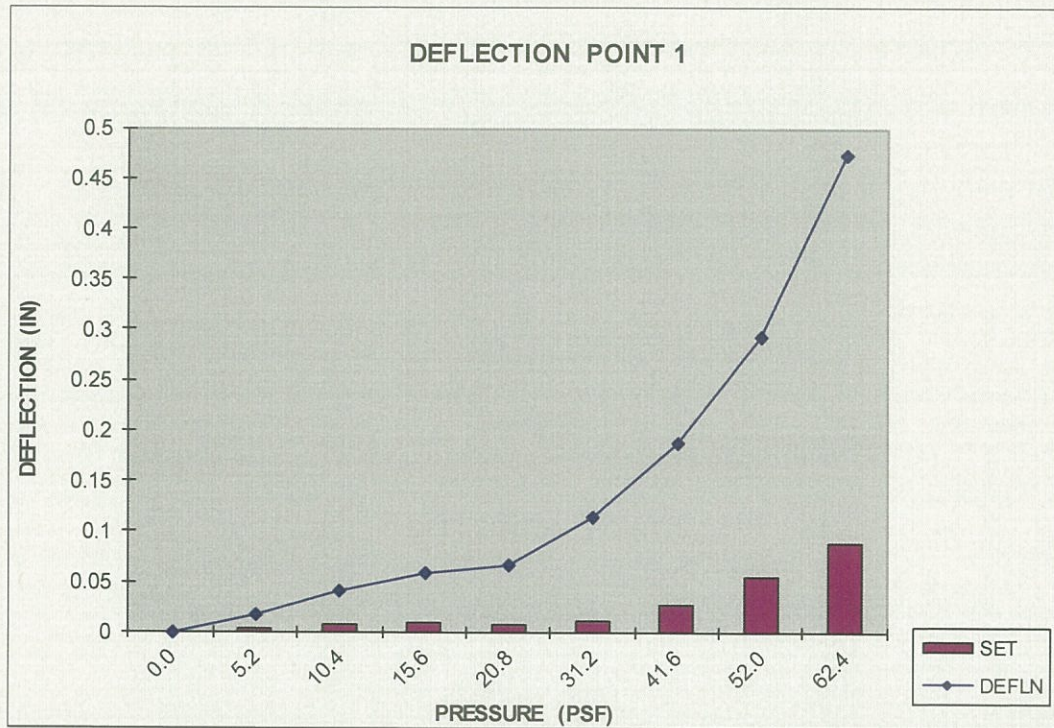

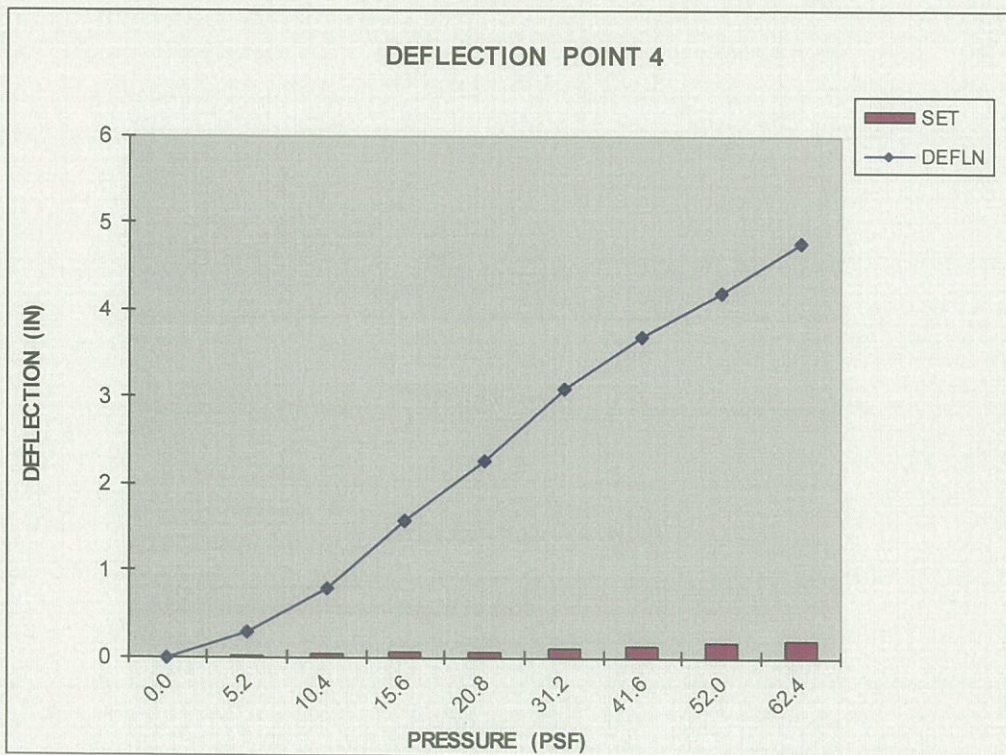
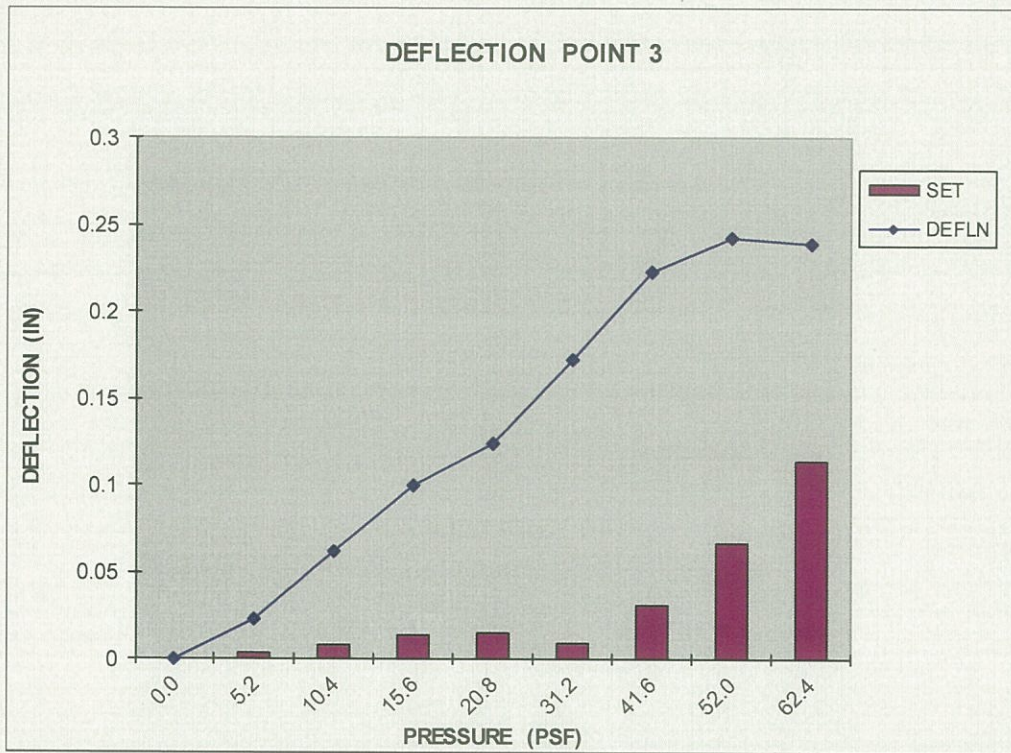

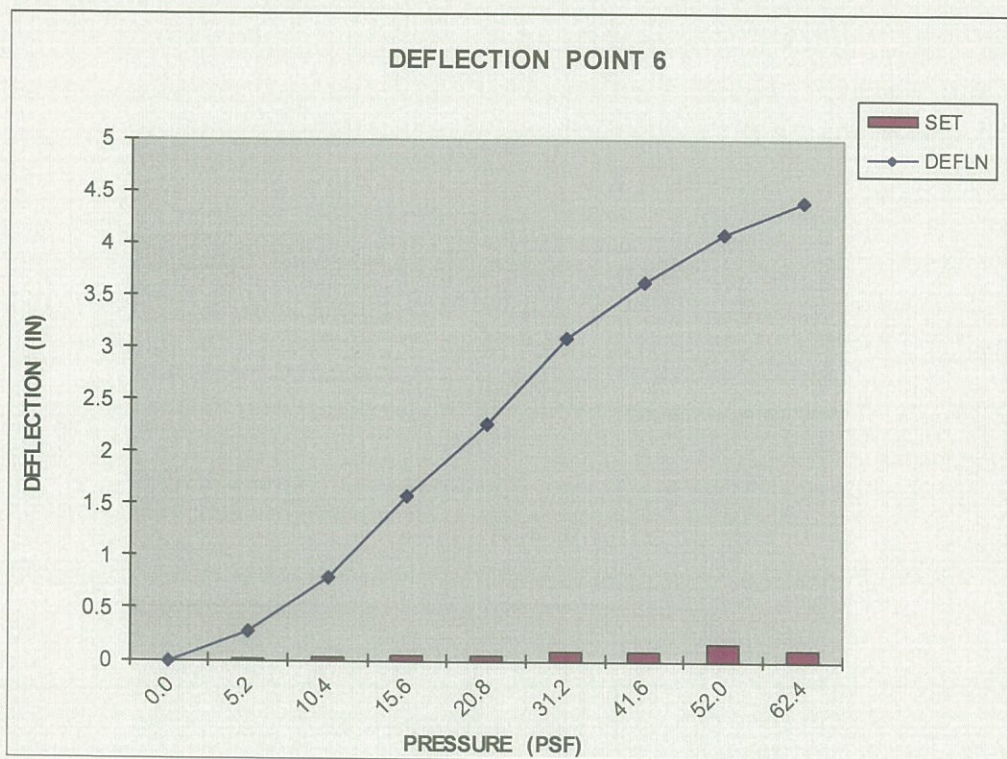
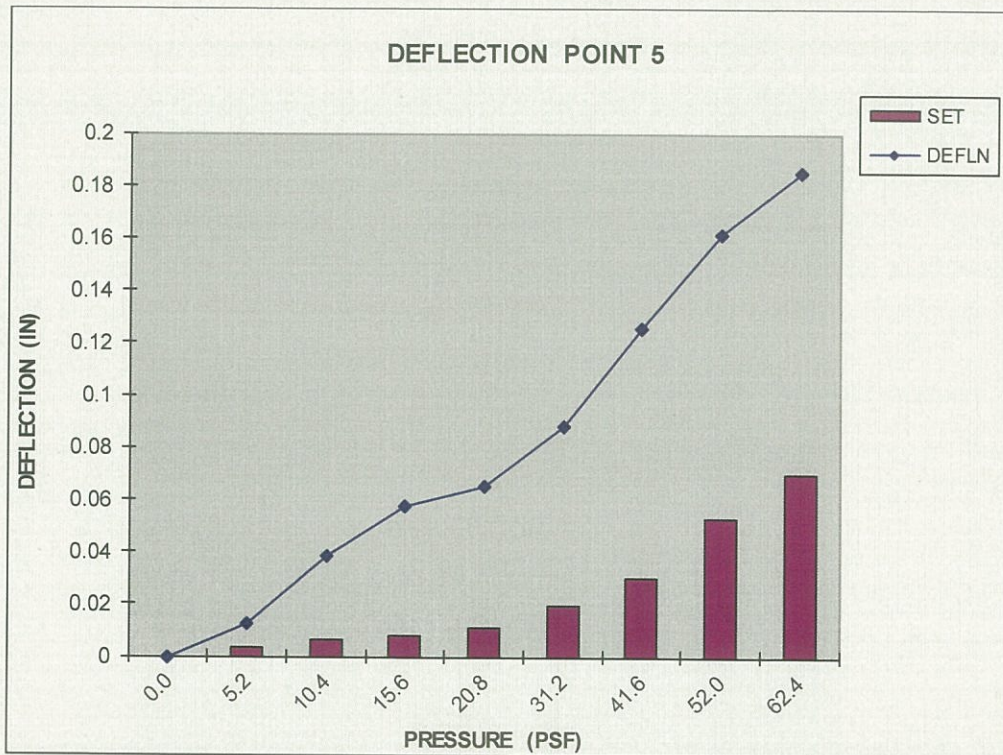

Project No. T140-19

TEST #2

Specimen: T-PANEL - Metal Roof Panel, 16" wide x 24 ga. steel with continuous Clip

Clip Spacing: 5 ft o/c

NEGATIVE (UPLIFT) PRESSURE

PETERSEN ALUM. T-PANEL 16" WIDE X 24 GA. STEEL (5 SPANS @ 5' O.C.) CONT. CLIP

LOAD (PSF)	DEFLECTION DIAL READINGS (INCHES)					
	D-1	D-2	D-3	D-4	D-5	D-6
0.0	0.000	0.000	0.000	0.000	0.000	0.000
15.6	0.035	1.150	0.041	1.243	0.008	1.229
0.0	0.005	0.014	0.005	0.011	0.002	0.006
31.2	0.091	1.990	0.104	2.094	0.018	2.104
0.0	0.008	0.044	0.010	0.034	0.006	0.038
46.8	0.157	2.475	0.175	2.577	0.046	2.597
0.0	0.013	0.060	0.018	0.037	0.012	0.047
62.4	0.236	2.883	0.259	2.967	0.078	3.008
0.0	0.025	0.095	0.034	0.061	0.021	0.079
78.1	0.331	3.251	0.353	3.309	0.100	3.364
0.0	0.051	0.161	0.060	0.108	0.029	0.133
93.7	0.430	3.623	0.448	3.599	0.113	3.745
0.0	0.078	0.232	0.083	0.158	0.030	0.202
109.3	0.544	4.000	0.560	3.908	0.128	4.117
0.0	0.100	0.429	0.118	0.230	0.040	0.429
124.9	0.673	4.410	0.691	4.246	0.136	4.520
0.0	0.128	1.120	0.163	0.438	0.047	1.301
140.5	0.831	4.822	0.852	4.576	0.146	4.908
0.0	0.186	2.011	0.226	2.217	0.055	2.234

RESULTS:

Based on FM 4474 Test Method Appendix D

Maximum Test Load Rating (held for 1 min.) = 195.0 psf

Additional Test Pressure that was held for a minute was 197.6 psf

Maximum Test Load = 200.2 psf (clip fastener pulled thru clip)

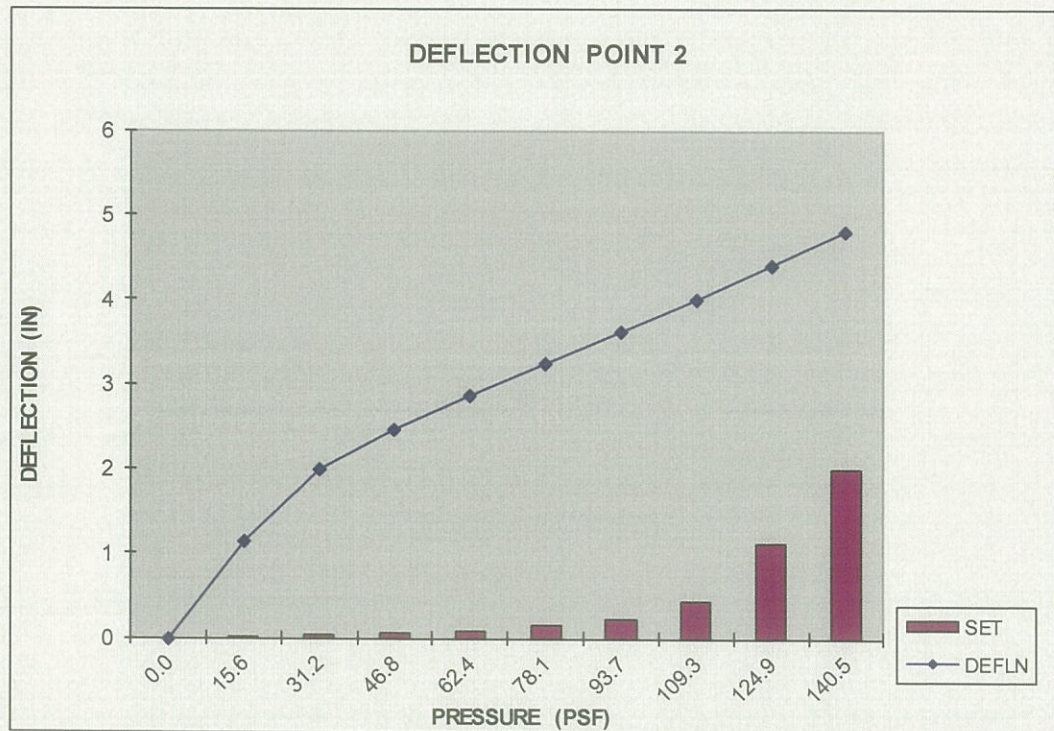
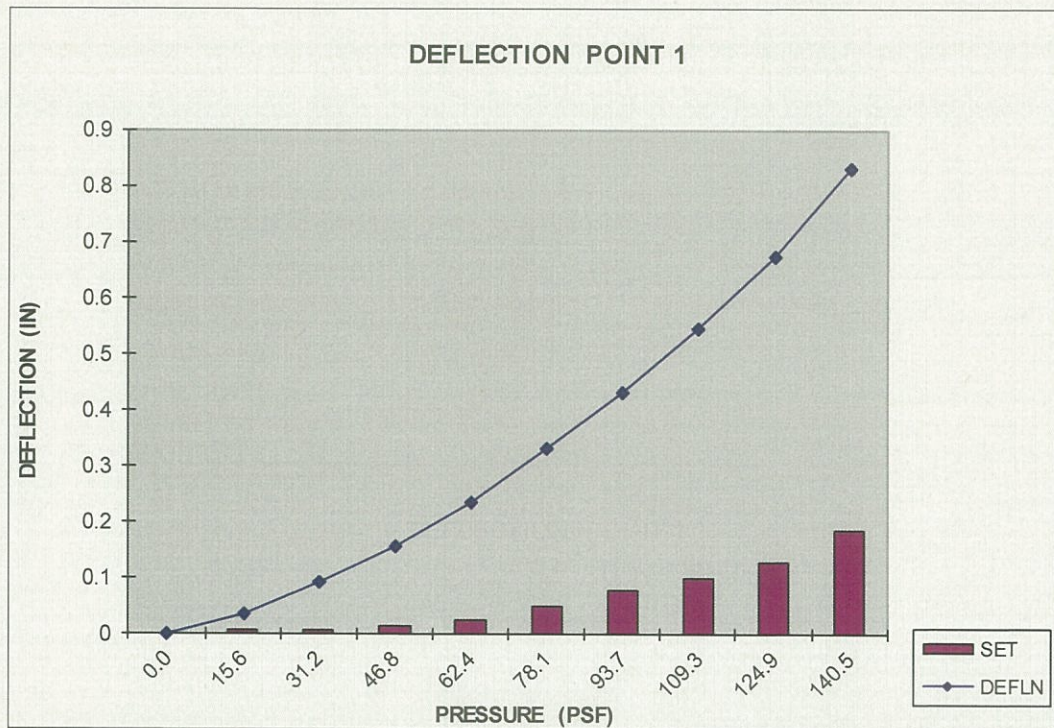

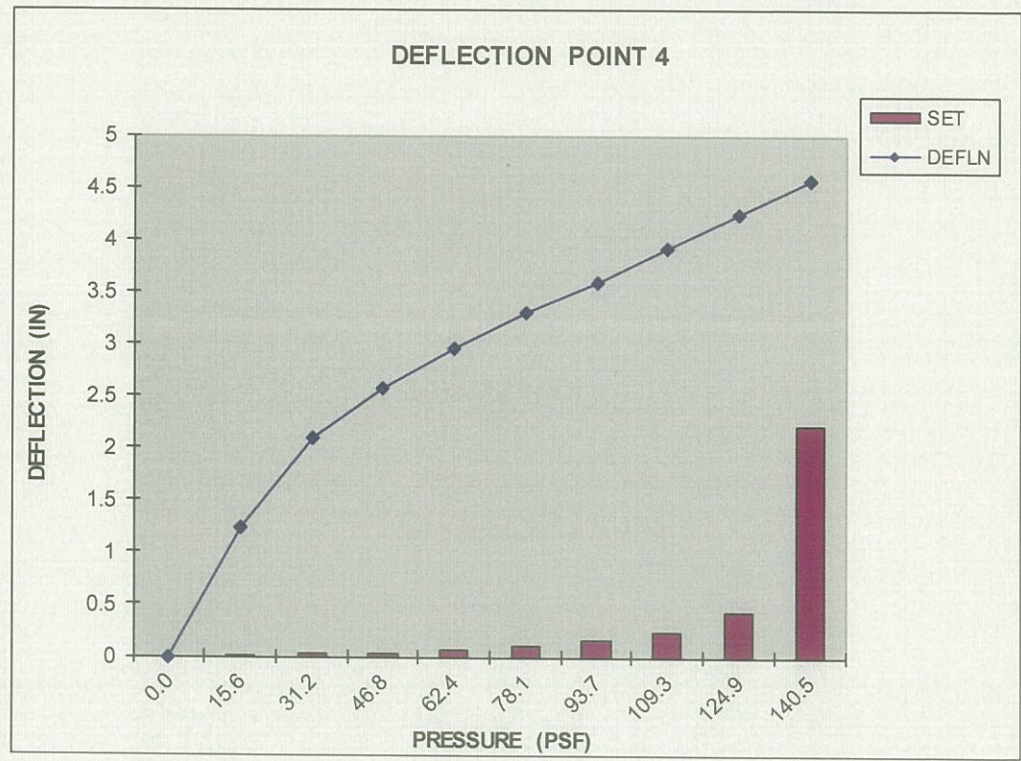
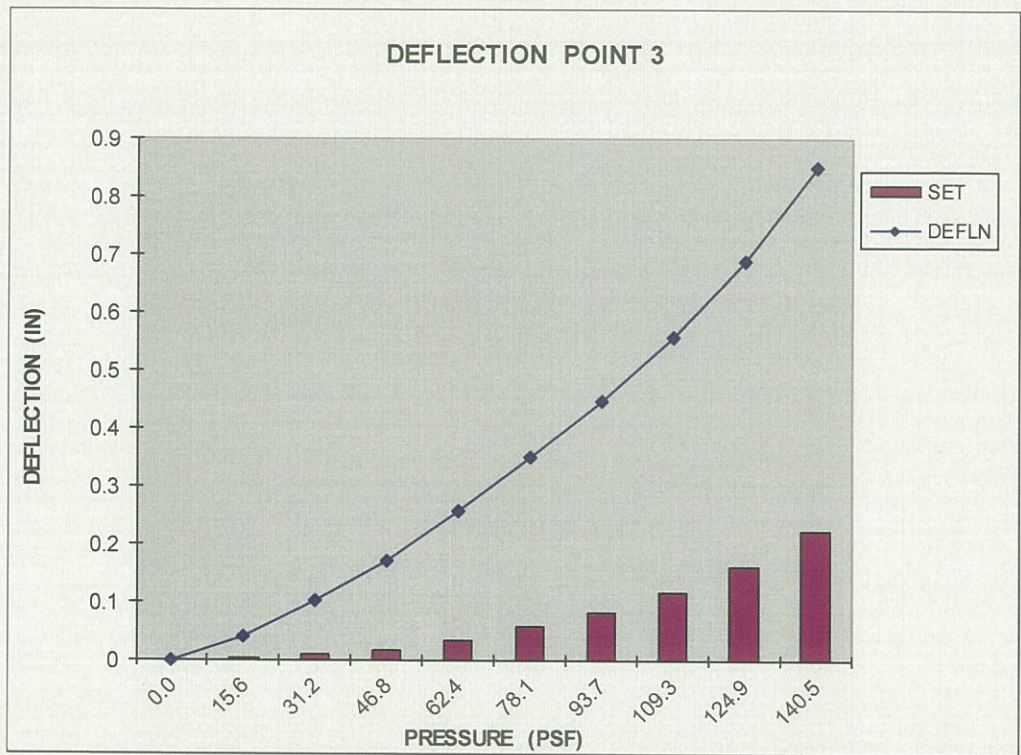

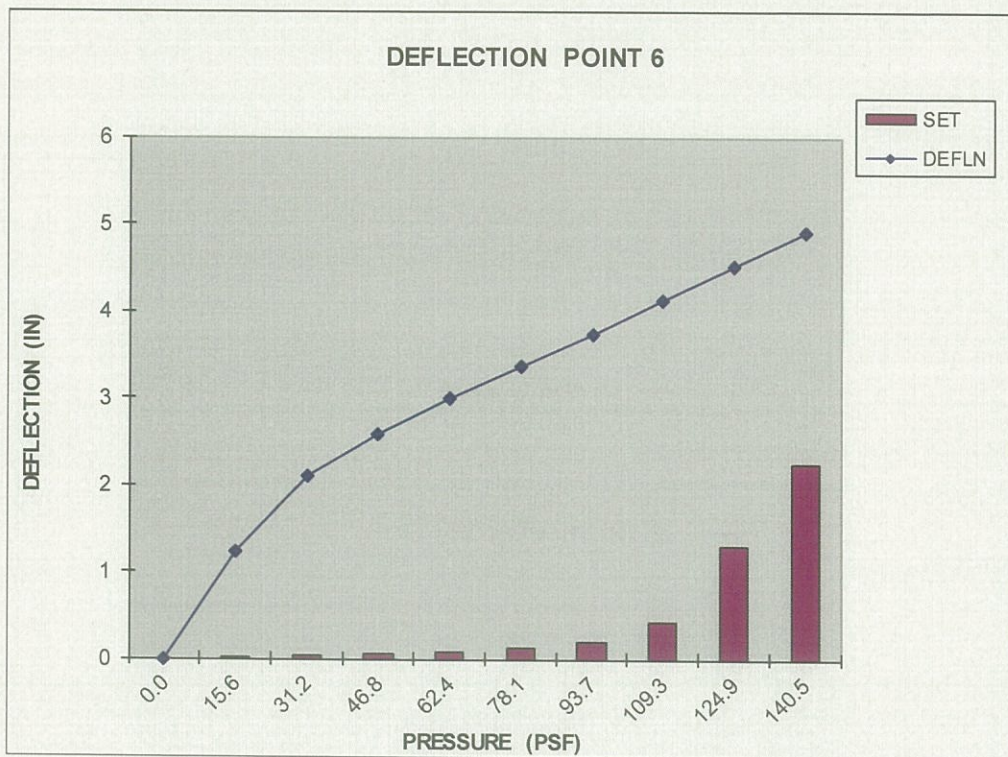
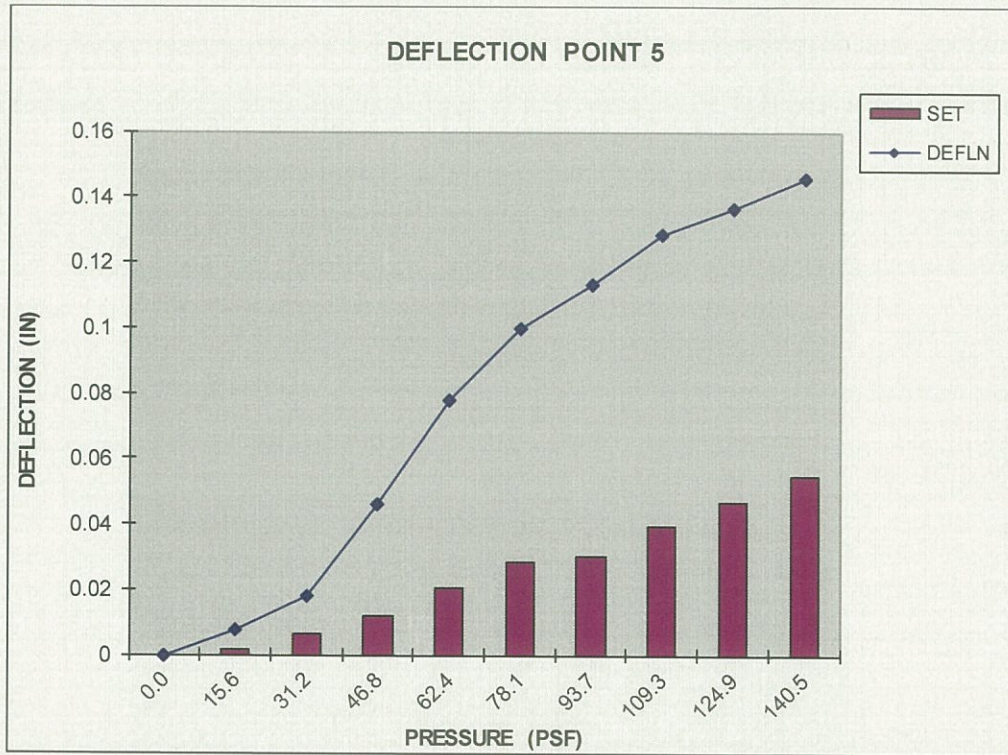

Project No. T140-19

TEST #3

Specimen: T-PANEL - Metal Roof Panel, 16" wide x 24 ga. steel with intermittent Clip

Clip Spacing: 2 ft o/c

NEGATIVE (UPLIFT) PRESSURE

PETERSEN ALUM. T-PANEL 16" WIDE X 24 GA. STEEL (12 SPANS @ 2' O.C.) INTERMITTENT CLIP

LOAD (PSF)	DEFLECTION DIAL READINGS (INCHES)					
	D-1	D-2	D-3	D-4	D-5	D-6
0.0	0.000	0.000	0.000	0.000	0.000	0.000
15.6	1.302	0.023	1.375	0.021	1.335	0.021
0.0	0.035	0.010	0.049	0.012	0.029	0.006
31.2	2.403	0.037	2.550	0.034	2.473	0.030
0.0	0.066	0.013	0.085	0.015	0.060	0.009
46.8	2.968	0.059	3.143	0.063	3.071	0.046
0.0	0.137	0.023	0.149	0.024	0.130	0.013
62.4	3.376	0.085	3.606	0.098	3.537	0.063
0.0	0.150	0.038	0.175	0.040	0.141	0.017
78.1	3.691	0.108	4.072	0.133	3.994	0.068
0.0	0.187	0.058	0.211	0.060	0.178	0.016
93.7	3.710	0.149	4.384	0.143	4.340	0.081
0.0	0.302	0.074	0.240	0.083	0.296	0.017
109.3	3.830	0.164	4.718	0.151	4.699	0.099
0.0	0.521	0.087	0.261	0.098	0.523	0.023
124.9	3.992	0.179	5.041	0.175	5.073	0.132
0.0	0.580	0.116	0.501	0.124	0.592	0.043

RESULTS:

Based on FM 4474 Test Method Appendix D

Maximum Test Load Rating (held for 1 min.) = 120.0 psf

Additional Test Pressure that was held for a minute was 130.0 psf

Maximum Test Load = 134.7 psf (Panel disengaged from clip – Clip straightened out)

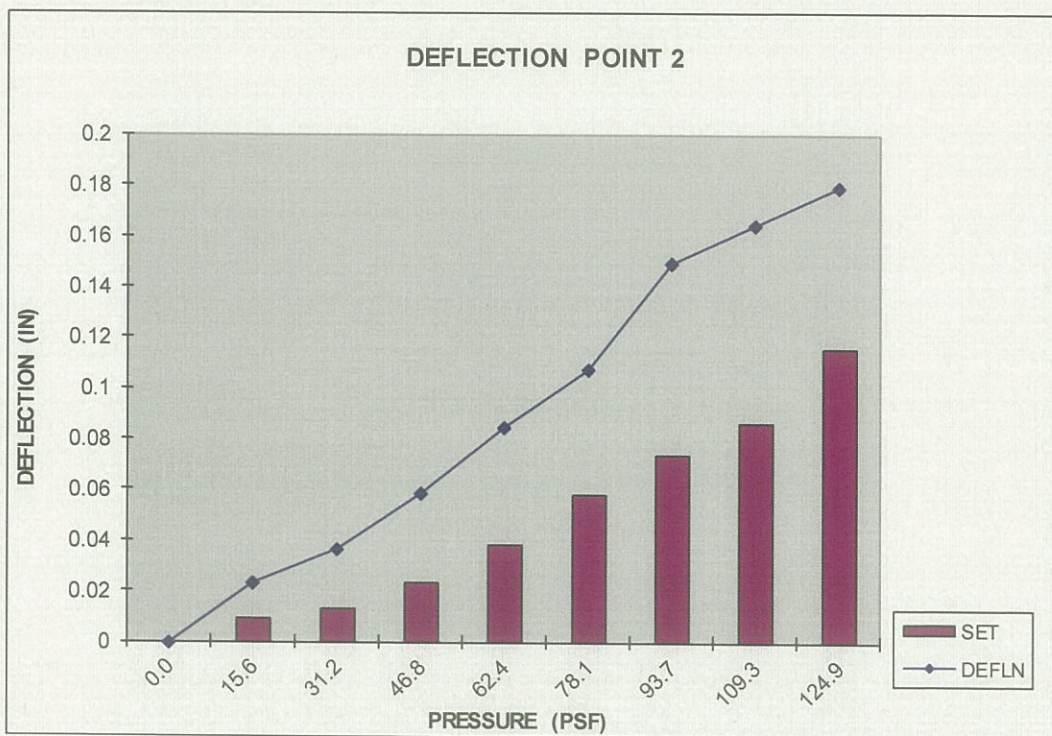
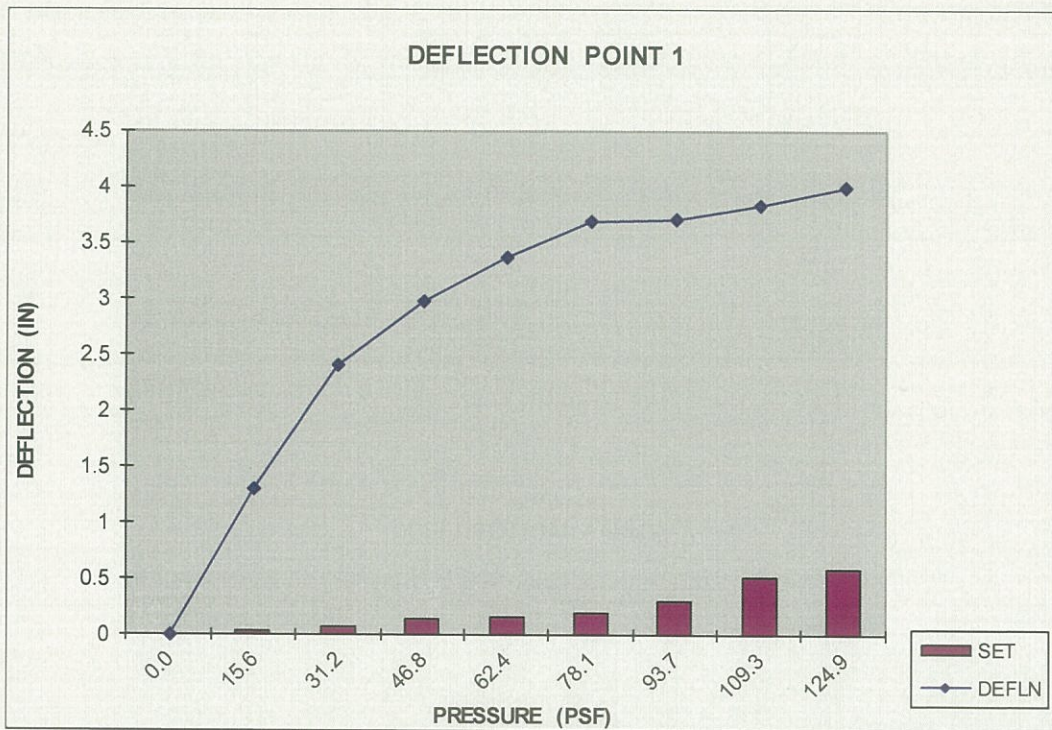

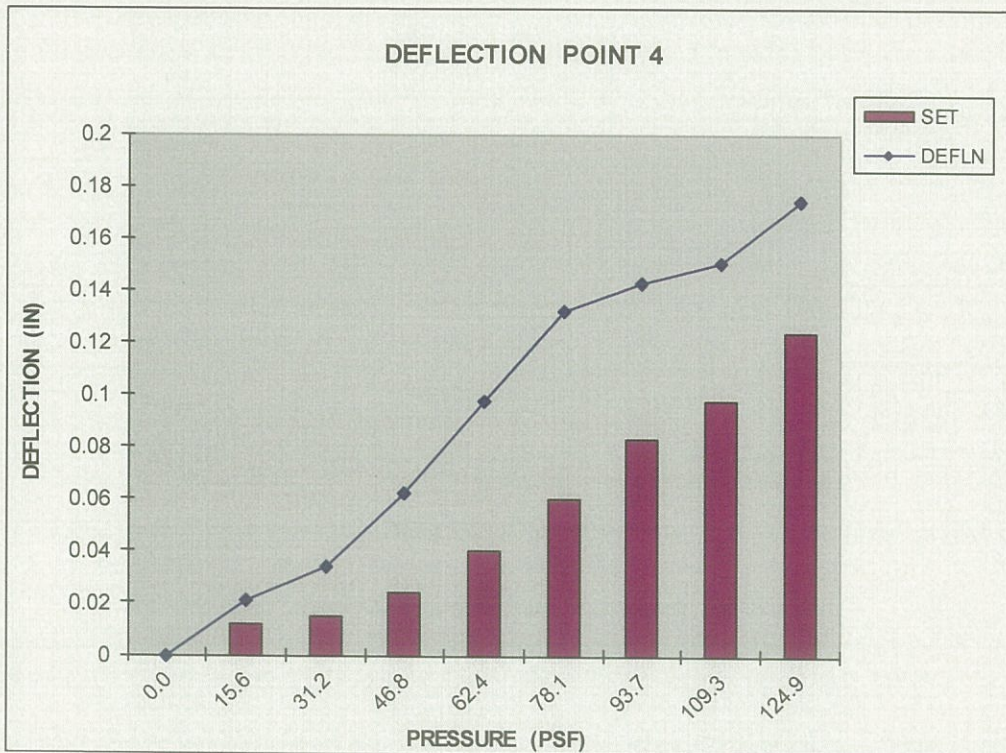
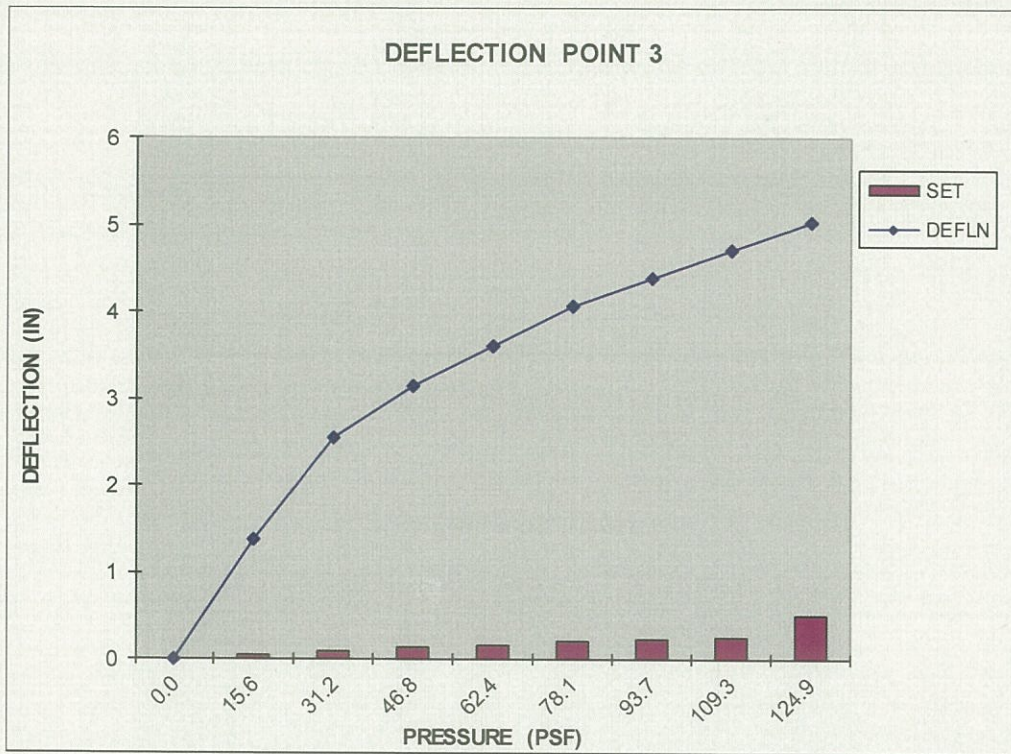

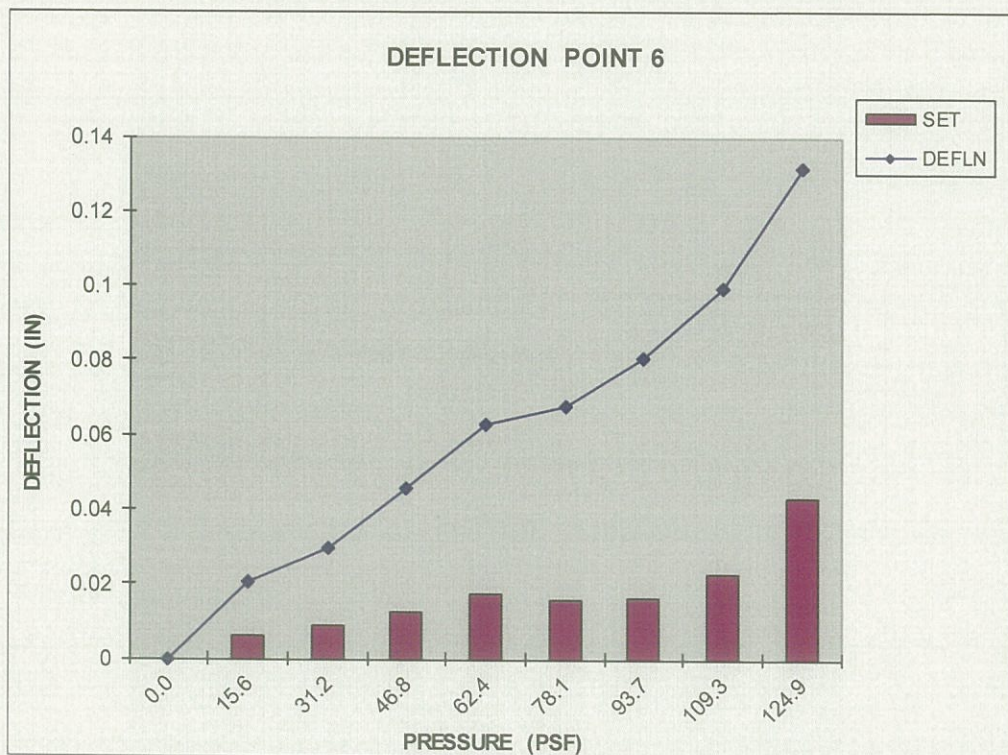
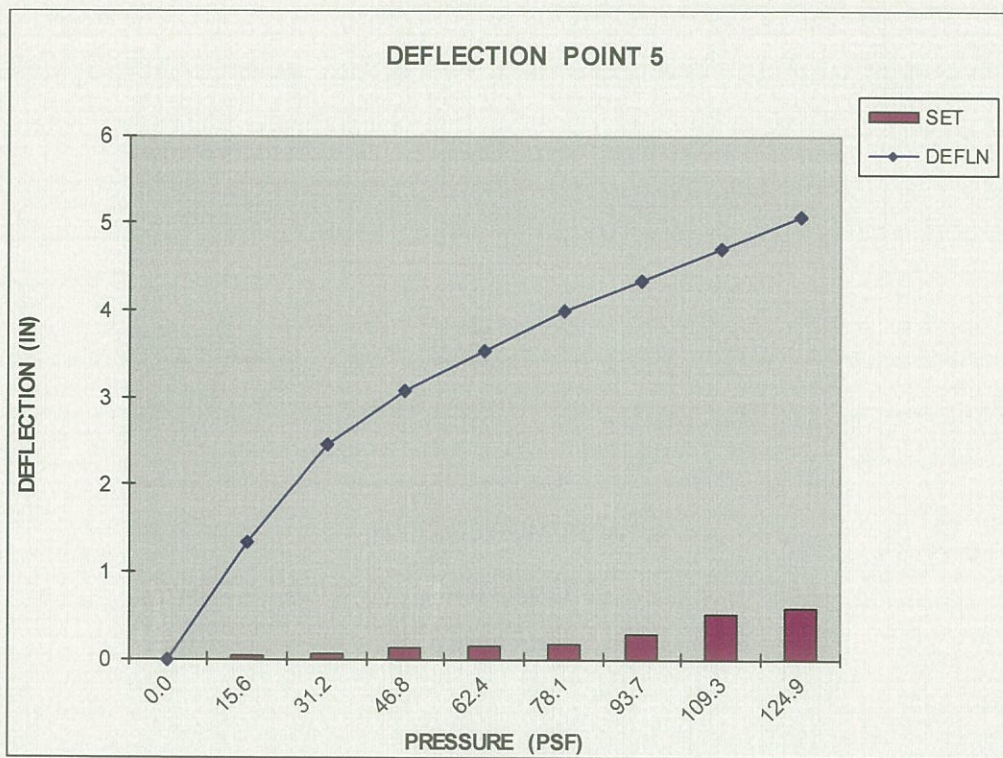

Project No. T140-19

TEST #4

Specimen: T-PANEL - Metal Roof Panel, 16" wide x 24 ga. steel with continuous Clip

Clip Spacing: 2 ft o/c

NEGATIVE (UPLIFT) PRESSURE

PETERSEN ALUM. T-PANEL 16" WIDE X 24 GA. STEEL (12 SPANS @ 2' O.C.) CONT. CLIP

LOAD (PSF)	DEFLECTION DIAL READINGS (INCHES)					
	D-1	D-2	D-3	D-4	D-5	D-6
0.0	0.000	0.000	0.000	0.000	0.000	0.000
15.6	1.092	0.006	1.108	0.005	1.196	0.004
0.0	0.018	0.002	0.013	0.002	0.017	0.001
31.2	1.975	0.010	2.053	0.009	2.178	0.005
0.0	0.055	0.002	0.038	0.001	0.045	0.004
46.8	2.466	0.018	2.523	0.010	2.681	0.016
0.0	0.067	0.001	0.048	0.000	0.065	0.005
62.4	2.892	0.018	2.911	0.011	3.108	0.017
0.0	0.102	0.001	0.077	0.000	0.095	0.005
78.1	3.087	0.021	3.086	0.013	3.313	0.017
0.0	0.121	0.002	0.091	0.002	0.117	0.006
93.7	3.419	0.023	3.360	0.013	3.631	0.018
0.0	0.189	0.002	0.141	0.008	0.180	0.006
109.3	3.570	0.024	3.475	0.016	3.795	0.019
0.0	0.243	0.004	0.168	0.009	0.209	0.007
124.9	3.821	0.024	3.658	0.016	4.040	0.021
0.0	0.543	0.006	0.350	0.011	0.414	0.007
140.5	4.078	0.027	3.860	0.023	4.313	0.021
0.0	1.312	0.009	0.708	0.016	0.767	0.008
156.1	4.463	0.043	4.137	0.040	4.733	0.023
0.0	2.417	0.016	2.558	0.024	2.795	0.009
171.7	4.587	0.051	4.207	0.043	4.876	0.023
0.0	2.775	0.021	2.867	0.028	3.157	0.013

RESULTS:

Based on FM 4474 Test Method Appendix D

Maximum Test Load Rating (held for 1 min.) = 225.0 psf

Additional Test Pressure that was held for a minute was 239.7 psf

Maximum Test Load = 239.7 psf (No Failures)

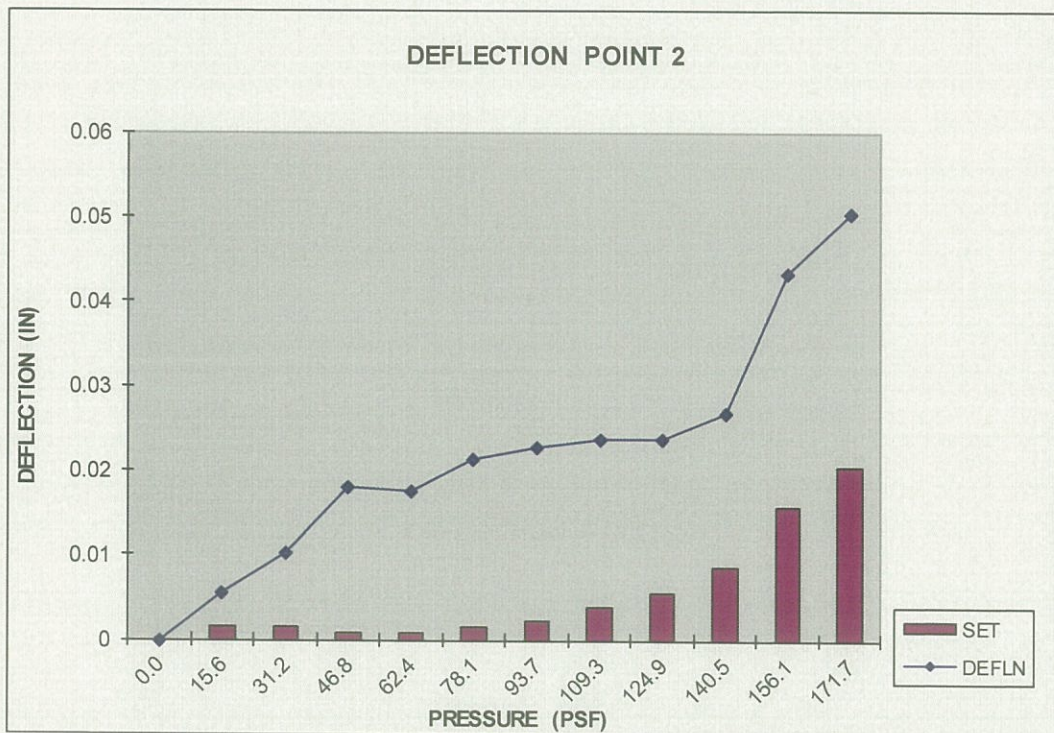
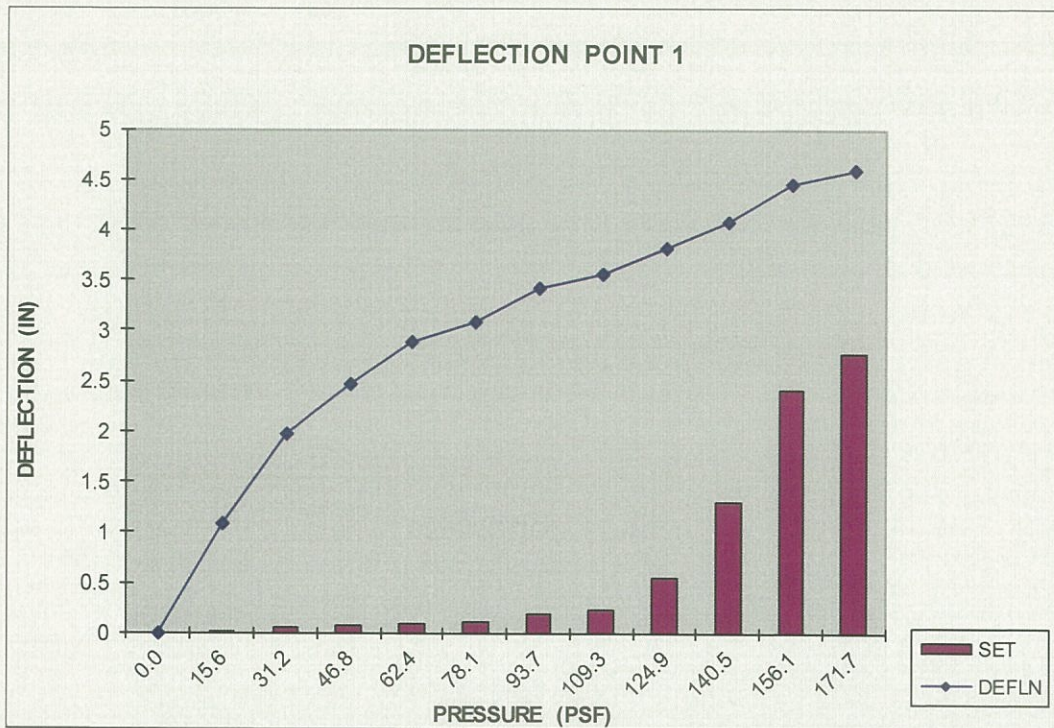

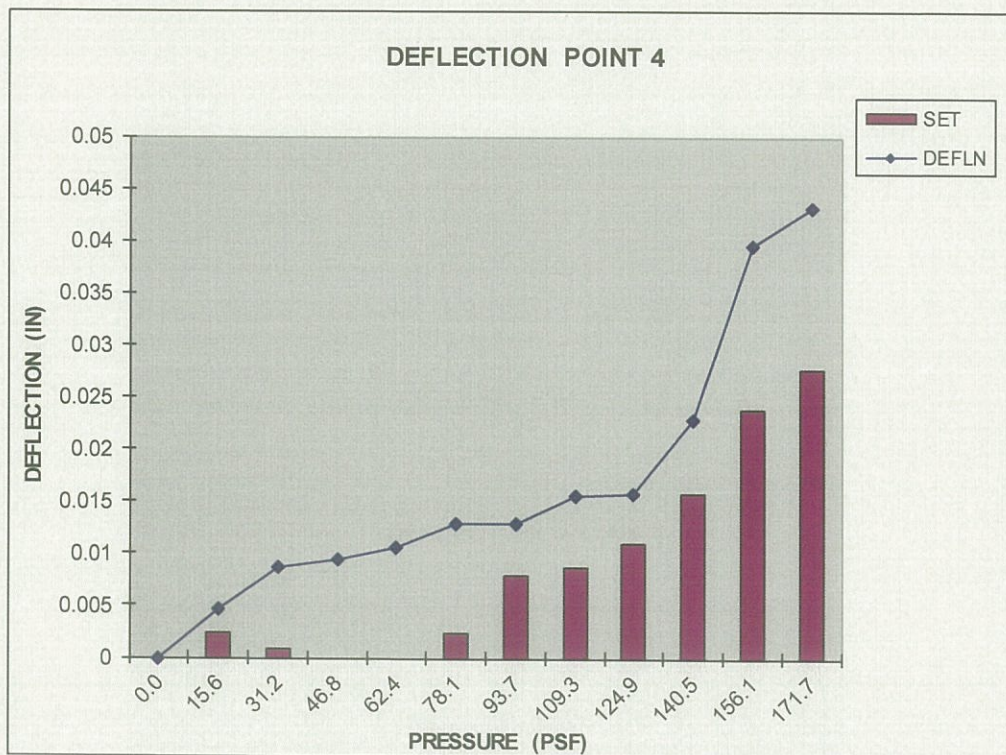
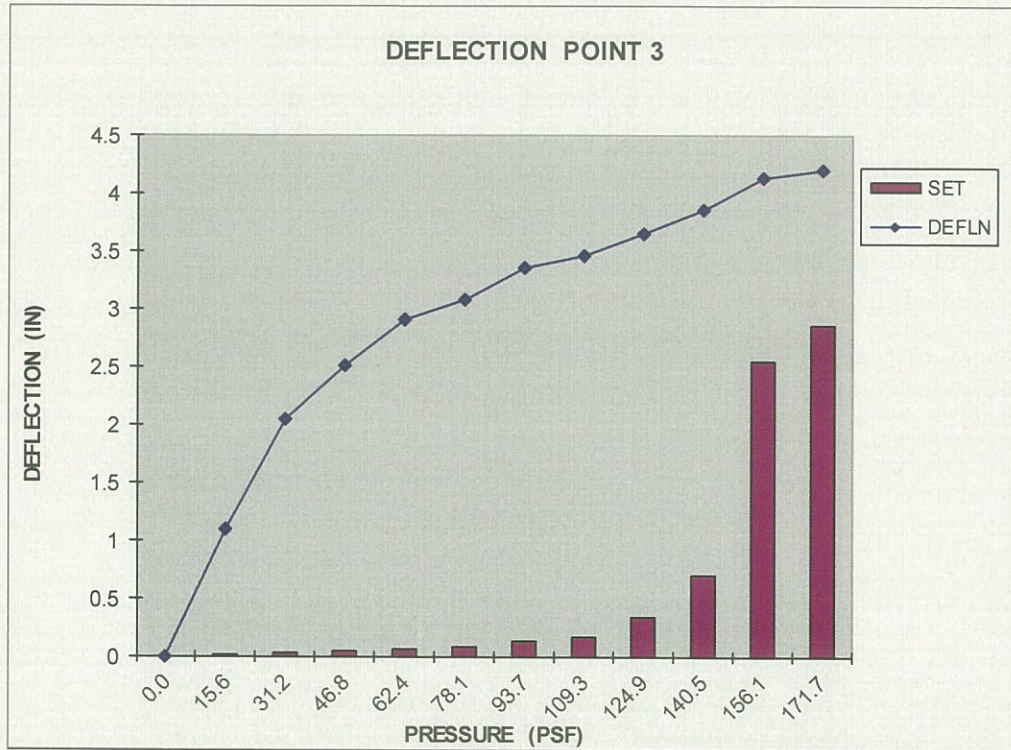

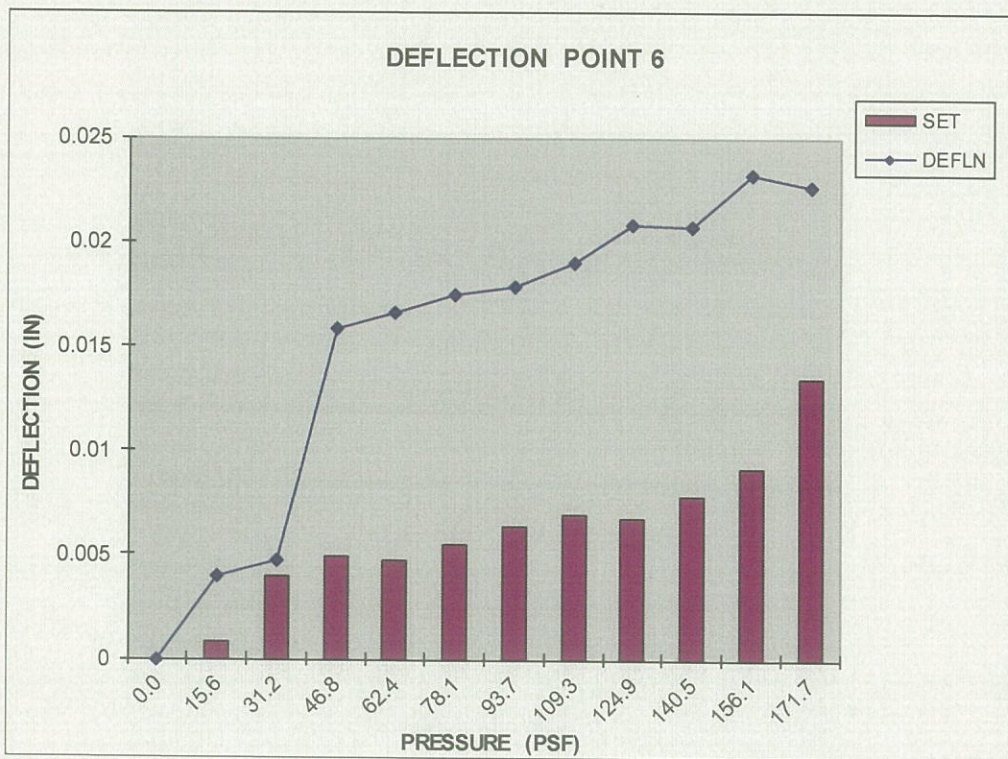
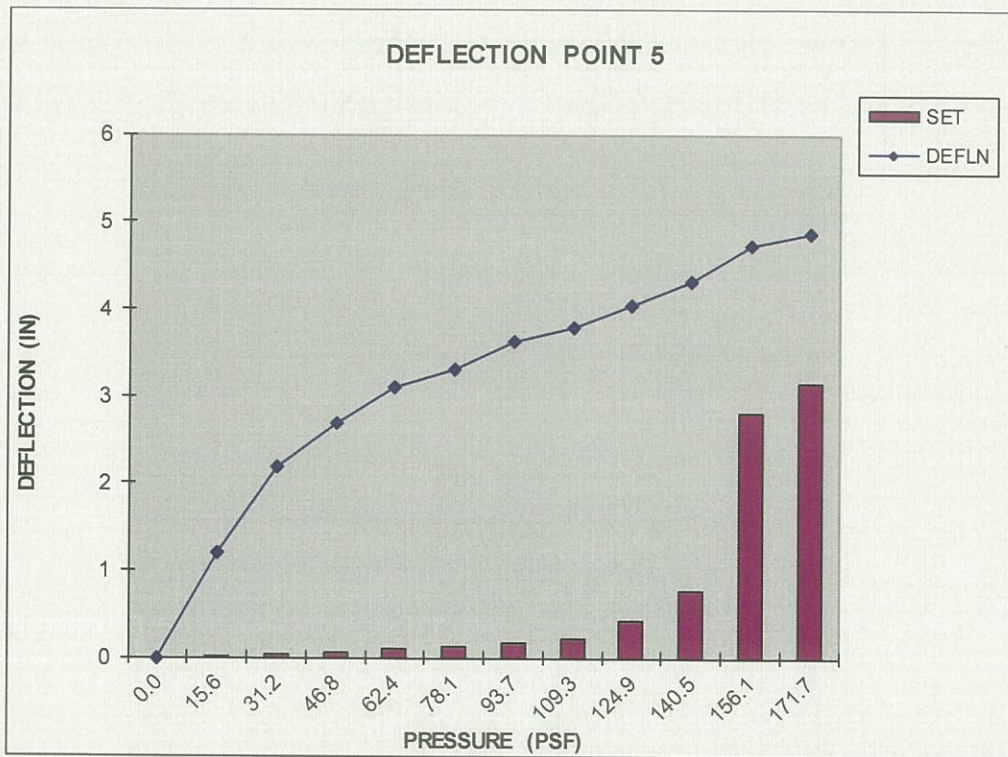

TEST #1 & #2

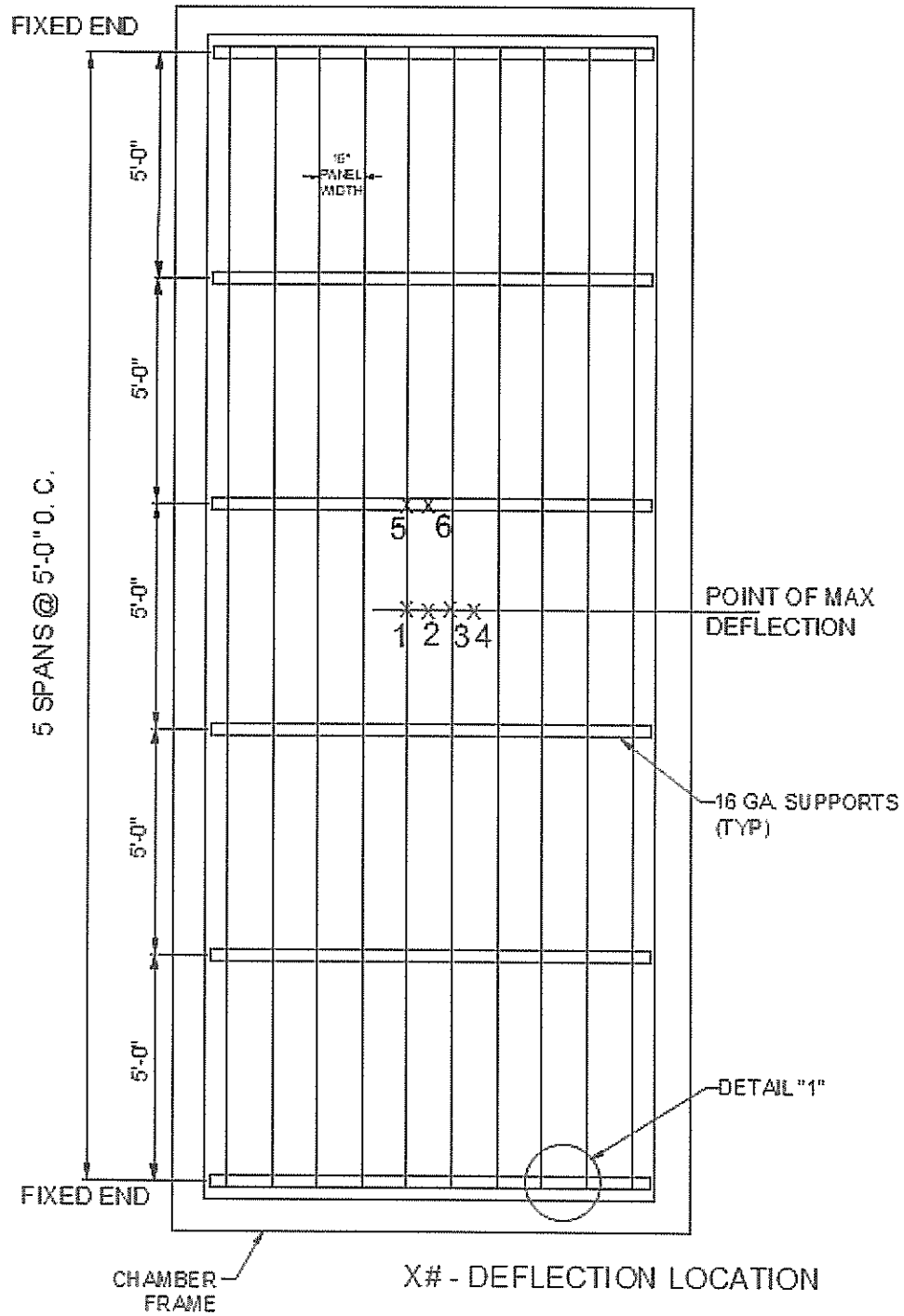

PLAN VIEW

1/4-14 SELF DRILLING FASTENERS
(5 PER PANEL AT FIXED ENDS)

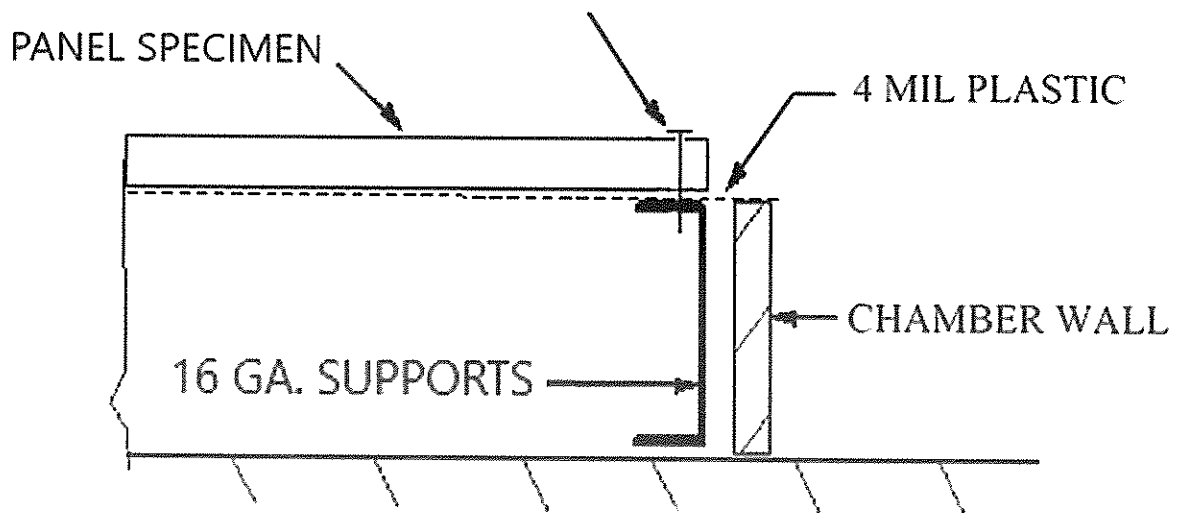

DETAIL 1

Project No. T140-19

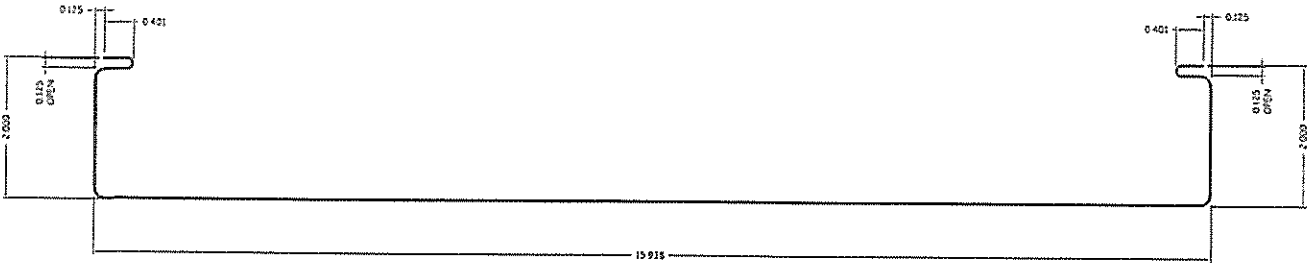

16" T PANEL

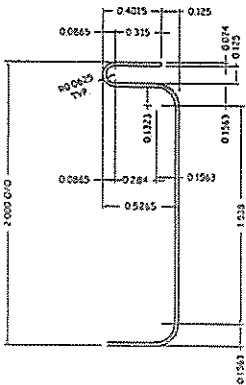
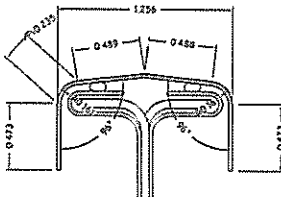
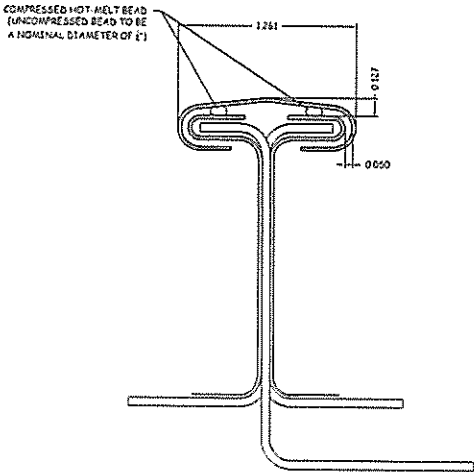

ENLARGED SIDE JOINT DETAIL

STUDY AT SIDE JOINT W/ CLIP CAP (AFTER SEAMING)

PANEL PROFILE

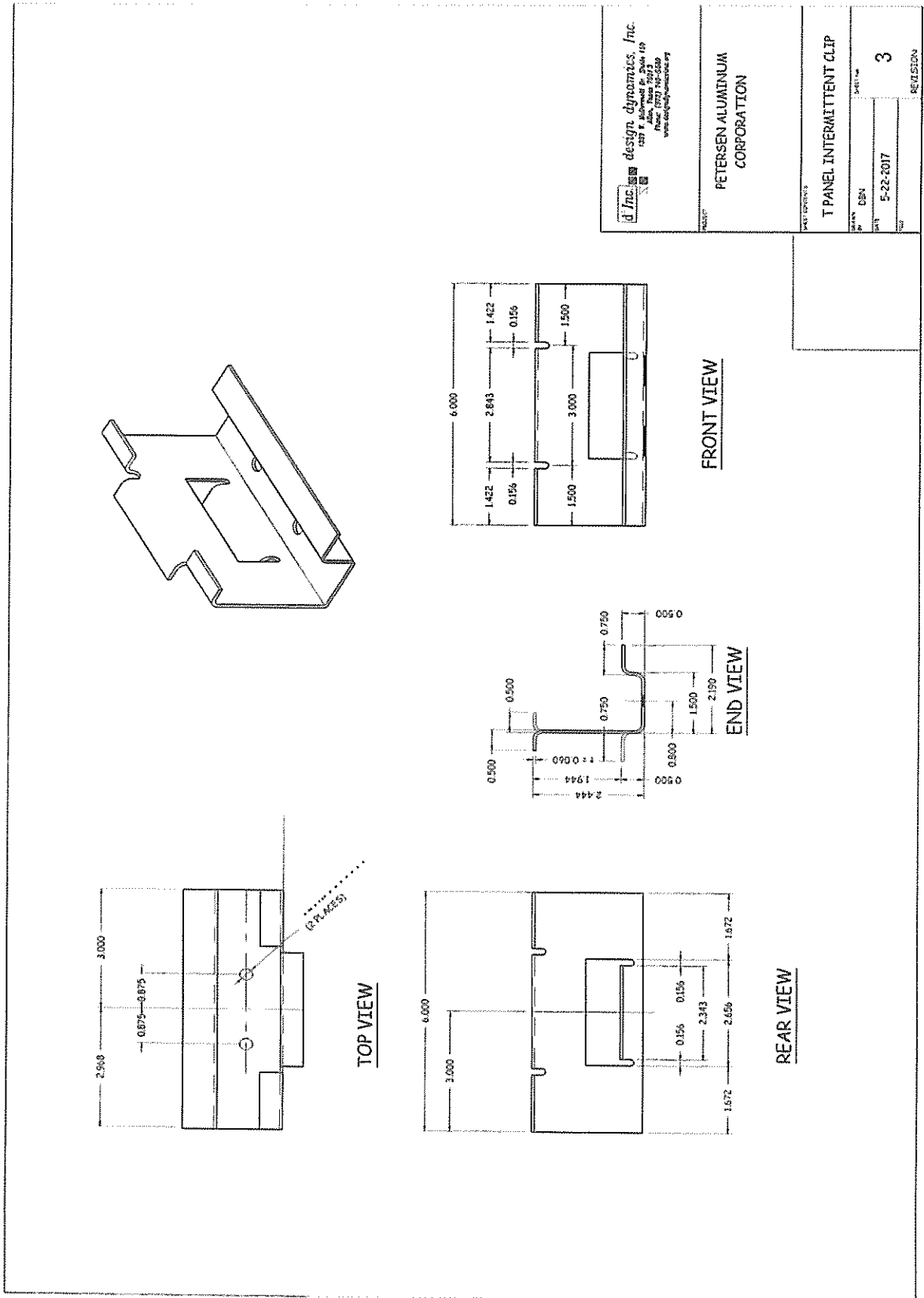

d Inc. design dynamics, Inc.
 1237 E. Main St. Suite 100
 Aliso Viejo, CA 92606
 Tel: (949) 485-6669
 www.dynamics.com

PETERSEN ALUMINUM CORPORATION

T PANEL INTERMITTENT CLIP

DATE: 5-22-2017

REV: 3

REVISION:

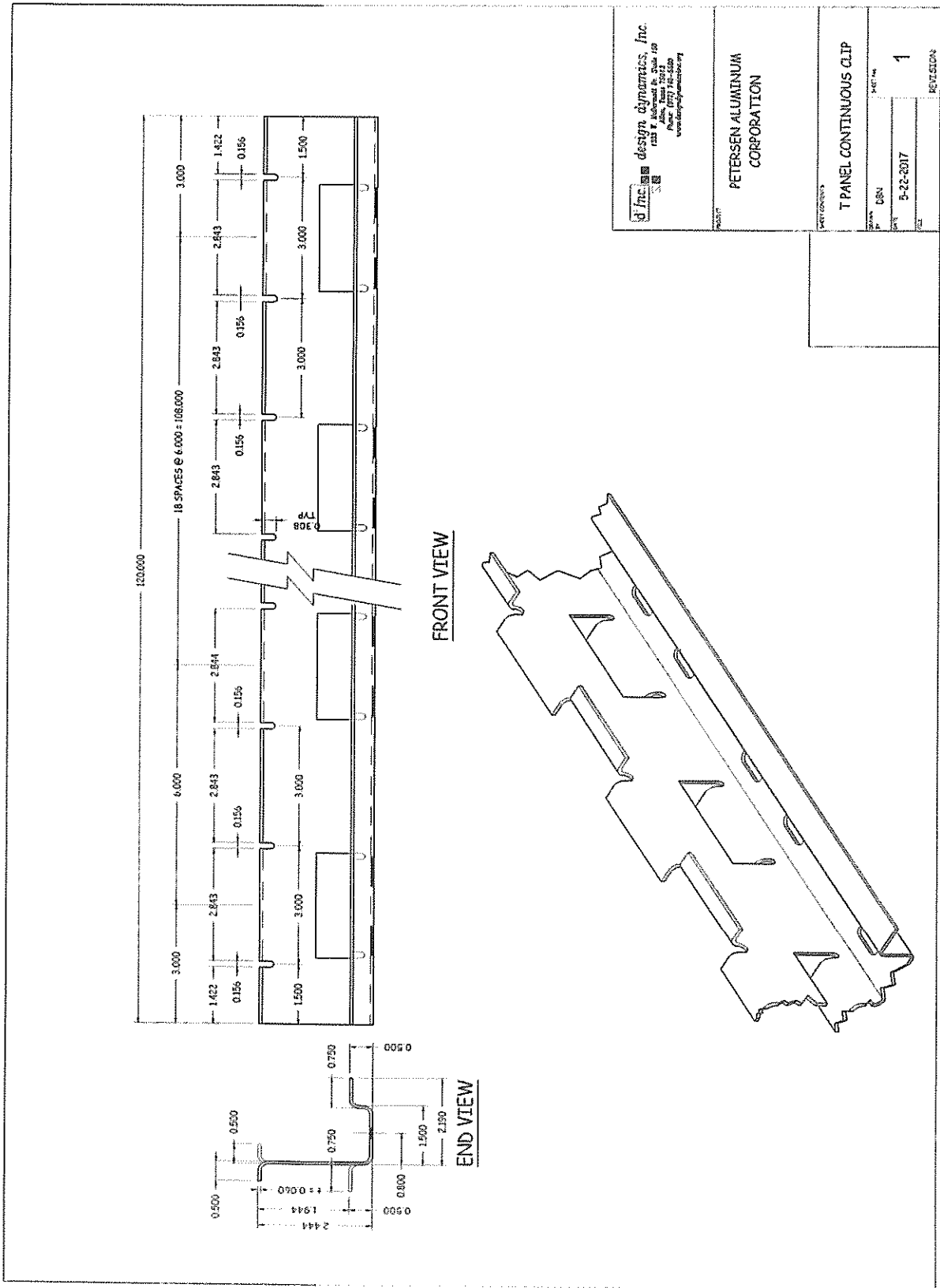

Project No. T140-19

TENSILE TEST REPORT

Client: Petersen Aluminum
10551 PAC Rd.
Tyler, TX. 75707

Test Date: February 8, 2019

Test Method: ASTM A370-10

Material Description: T-PANEL - Metal Roof Panel, 16" wide x 24 ga. steel

Sample No.	Width (in)	Thickness (in)	Yield Load (lb)	Max. Load (lb)	0.2% Offset Yield Strength (psi)	Tensile Strength (psi)	Elongation (% in 2 inches)
19008	0.500	0.022	644.3	690.6	58,568	62,783	19.8

Equipment Used: Tensile Machine #QT7-061196-020
Caliper #1074379
Extensometer #10311744D
Micrometer #110596927